



*Portable Grand* DGX-670  
Reference Manual

This Reference Manual explains advanced features of the DGX-670.  
Please read the Owner's Manual first, before reading this Reference Manual.

# Table of Contents

Each chapter in this Reference Manual corresponds to the relevant chapters in the Owner's Manual.

<b>1 Piano Room</b>	<b>3</b>	<b>5 USB Audio Player/Recorder</b>	<b>58</b>
<b>2 Voices</b>	<b>3</b>	<b>6 Microphone</b>	<b>58</b>
Voice Characteristics .....	4	Making and Saving the Microphone Settings.....	58
Metronome Settings.....	5	Applying Desired Effects to the Microphone Sound.....	60
Adjusting the Reverb/Chorus Depth and Other Settings for Piano Voices .....	6	<b>7 Registration Memory/Playlist</b>	<b>61</b>
Applying Keyboard Harmony .....	7	Deleting or Renaming the Registration Memory .....	61
Pitch-Related Settings .....	10	Disabling Recall of Specific Items (Freeze) .....	62
Editing Voices (Voice Set) .....	12	Calling Up Registration Memory Numbers in Order (Registration Sequence) .....	63
Disabling Automatic Selection of Voice Sets (Effects, etc.).....	17	Copying the Playlist Records from Another Playlist (Append Playlist).....	65
<b>3 Styles</b>	<b>18</b>	<b>8 Mixer</b>	<b>66</b>
Playing Style with the Smart Chord feature .....	19	Editing Volume/Pan Parameters .....	66
Learning How To Play Specific Chords (Chord Tutor).....	21	Editing Filter Parameters .....	67
Chord Types Recognized in Fingered .....	22	Editing Effect Parameters .....	68
Style Playback Related Settings .....	23	Editing EQ/Master EQ (Equalizer) Parameters.....	71
Specifying Chords with Your Right Hand while Playing Bass with Your Left Hand .....	25	Editing Compressor (Master Compressor) Parameters... 73	
Creating/Editing Styles (Style Creator) .....	26	Block Diagram.....	74
<b>4 Songs</b>	<b>44</b>	<b>9 Connections</b>	<b>75</b>
Editing Music Notation (Score) Settings .....	44	Assigning a Specific Function to Each Pedal.....	75
Editing Lyrics/Text Display Settings.....	47	MIDI Settings .....	79
Using the Auto Accompaniment Features with Song Playback .....	48	Making Wireless LAN Settings.....	85
Song Playback Related Parameters (Guide Function, Channel settings, Repeat settings, etc.) .....	49	<b>10 Menu</b>	<b>87</b>
Creating/Editing Songs (Song Creator) .....	52	Utility .....	87
		System .....	90
		<b>Index</b>	<b>92</b>

## Using the PDF manual

- To quickly jump to items and topics of interest, click on the desired items in the “Bookmarks” index to the left of the main display window. (Click the “Bookmarks” tab to open the index if it is not displayed.)
- Click the page numbers that appear in this manual to go directly to the corresponding page.
- Select “Find” or “Search” from the Adobe Reader “Edit” menu and enter a keyword to locate related information anywhere in the document.

**NOTE** The names and positions of menu items may vary according to the version of Adobe Reader being used.

- The illustrations and displays as shown in this manual are for instructional purposes only, and may appear somewhat different from those on your instrument.
- The explanations in this manual apply to the firmware version 1.00. Yamaha may from time to time update firmware of the product without notice for improvement. We recommend that you check our website for later releases and upgrade your firmware. <https://download.yamaha.com/>
- The company names and product names in this manual are the trademarks or registered trademarks of their respective companies.

# Piano Room

This function is fully explained in the Owner's Manual. Refer to the corresponding chapter in the Owner's Manual.

# Voices

## Contents

<b>Voice Characteristics</b> .....	<b>4</b>
<b>Metronome Settings</b> .....	<b>5</b>
<b>Adjusting the Reverb/Chorus Depth and Other Settings for Piano Voices</b> .....	<b>6</b>
<b>Applying Keyboard Harmony</b> .....	<b>7</b>
<b>Pitch-Related Settings</b> .....	<b>10</b>
• Fine-tuning the Pitch of the Entire Instrument .....	10
• Scale Tuning .....	10
• Pitch Settings for Each Keyboard Part .....	11
<b>Editing Voices (Voice Set)</b> .....	<b>12</b>
• Editable Parameters in the Voice Set Displays .....	13
<b>Disabling Automatic Selection of Voice Sets (Effects, etc.)</b> .....	<b>17</b>

## Voice Characteristics

The preset Voices are categorized into the types listed below. Refer to the “Voice List” in the Data List (separate PDF) to see the type of each Voice.

VRM (Virtual Resonance Modeling)	See the Owner’s Manual, Chapter 2.
S.Art! (Super Articulation)	See the Owner’s Manual, Chapter 2.
Natural!	Natural! Voices are high quality sounds on many specialist sampling techniques. They are especially suited to recreating Piano and other keyboard instruments.
Live!	Live! Voices feature stereo sampling, to reproduce accurately the stereo image of an acoustic instrument, as well as the ambience of the room it was recorded in.
Cool!	Cool! Voices reproduce the complex characteristics of Electric Instruments, by utilizing sophisticated programming techniques in both voicing, and the use of DSP effects.
Sweet!	Sweet! Voices are acoustic instruments which feature the sampled vibrato of the original player, creating a far more realistic and emotional performance than synthesized vibrato.
Drums	Drum & Percussion instruments are mapped across the keyboard so you can play them directly, or use in music production.
Live! Drums	Stereo sampling is used for these high definition Drum and Percussion instruments, which are mapped across the keyboard so you can play them directly, or use in music production.
SFX	Special percussion and sound effects are mapped across the keyboard, so you can play them directly, or use in music production.
Live! SFX	Stereo sampling is used for these high definition special percussion and sound effects, which are mapped across the keyboard so you can play them directly, or use in music production.
MegaVoice	<p>MegaVoice is a special Voice format designed for use in Styles and Songs, not for live performance. Different velocity ranges are used to select dramatically different playing styles simultaneously, and without changing the Voice.</p> <p>Actual sound maps for the MegaVoices are given in the Data List (separate PDF).</p> <p><b>NOTE</b> MegaVoices are not compatible with other instrument models. For this reason, any Song or Style you’ve created on this instrument using these Voices will not sound properly when played back on the instruments which do not have these types of Voices.</p> <p><b>NOTE</b> MegaVoices sound differently depending on keyboard range, velocity, touch, etc. Hence, if you apply keyboard harmony (page 7), change the transpose setting or change the Voice Set parameters, unexpected or undesired sounds may result.</p>

# Metronome Settings

You can set the time signature, volume and sound of the metronome, as well as the Tap Tempo percussion sound and its volume, which sounds when the [TEMPO/TAP] button is tapped.

## 1 Call up the operation display.

[MENU] → Cursor buttons [▲][▼][◀][▶] *Metronome Setting*, [ENTER]

## 2 Use the Cursor buttons [▲][▼] to select the page, and then use the [2 ▲▼] – [7 ▲▼] buttons to make necessary settings.

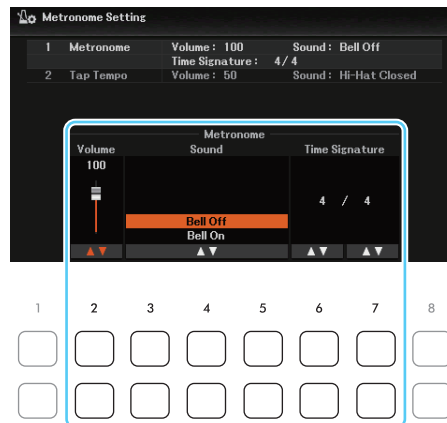

### 1 Metronome

[2 ▲▼]	<i>Volume</i>	Determines the volume of the metronome sound.
[3 ▲▼] – [5 ▲▼]	<i>Sound</i>	Determines whether a bell accent is sounded or not at the first beat of each measure.
[6 ▲▼]/ [7 ▲▼]	<i>Time Signature</i>	Determines the time signature of the metronome sound.

### 2 Tap Tempo

[2 ▲▼]	<i>Volume</i>	Determines the volume of the tap sound which sounds when the [TEMPO/TAP] button is tapped.
[3 ▲▼] – [5 ▲▼]	<i>Sound</i>	Selects the percussion sound which sounds when the [TEMPO/TAP] button is tapped.

# Adjusting the Reverb/Chorus Depth and Other Settings for Piano Voices

For the Piano Voices, you can set the VRM-related parameters and the volume of Key Off Sampling.

## 1 Call up the operation display.

[MENU] → Cursor buttons [▲][▼][◀][▶] *Voice Setting*, [ENTER] → TAB [◀] *Piano*

## 2 Use the Cursor buttons [▲][▼] to select the page, and then use the [1 ▲▼] – [8 ▲▼] buttons to make necessary settings.

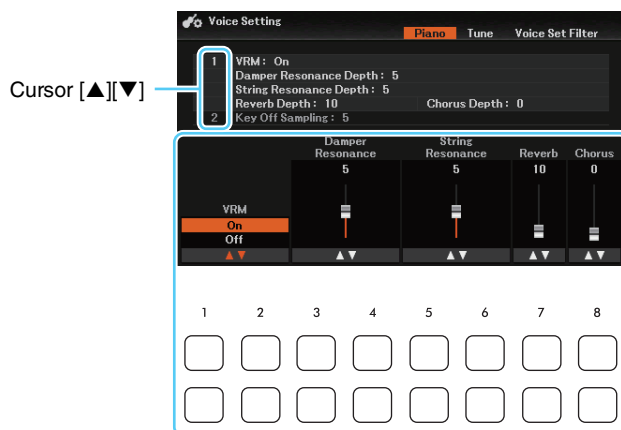

### 1 VRM

These settings are applied commonly to all parts (Main/Layer/Left) for which VRM Voices are selected.

[1 ▲▼]/ [2 ▲▼]	<b>VRM</b>	Turns the VRM effect on or off.
[3 ▲▼]/ [4 ▲▼]	<b>Damper Resonance</b>	Adjusts the depth of the VRM effect heard when pressing the damper pedal.
[5 ▲▼]/ [6 ▲▼]	<b>String Resonance</b>	Adjusts the depth of the VRM effect heard when playing the keyboard.
[7 ▲▼]	<b>Reverb</b>	Adjusts the Reverb depth for VRM Voices.
[8 ▲▼]	<b>Chorus</b>	Adjusts the Chorus depth for VRM Voices.

### 2 Key Off Sampling

These settings are applied commonly to all parts (Main/Layer/Left) for which the following piano Voices are selected:

*CFX Grand, PopGrand, StudioGrand, OctavePiano1, OctavePiano2, RockPiano, AmbientPiano, CocktailPiano.*

[4 ▲▼]/ [5 ▲▼]	<b>Key Off Sampling</b>	Adjusts the volume of the key-off sound (the subtle sound that occurs when you release a key).
-------------------	-------------------------	--

# Applying Keyboard Harmony

You can apply harmonies to your right-hand performance according to the chords you play with your left hand, and trigger automatic echo or tremolo even by pressing a single note or two notes.

- 1** Press the [VOICE EFFECT] button to call up the *Voice Effect* display, and then press the Cursor button [▼] to select **2 Keyboard Harmony**.
- 2** Use the [2 ▲▼]/[3 ▲▼] buttons to set *Keyboard Harmony* to **On**.  
When this is set to *On*, Keyboard Harmony is applied to your keyboard performance automatically.

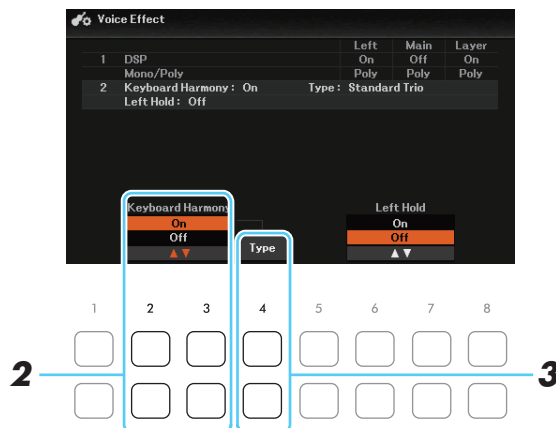

- 3** Call up the *Keyboard Harmony* display by pressing the [4 ▲▼] (*Type*) button.

**NOTE** The display can also be called up via [MENU] → Cursor buttons [▲][▼][◀][▶] *Keyboard Harmony*, [ENTER].

- 4** Use the [1 ▲▼] – [3 ▲▼] (*Category*) buttons to select the *Keyboard Harmony* category, and then use the [4 ▲▼] – [6 ▲▼] (*Type*) buttons to select the type.

Keyboard Harmonies are divided into two categories: Harmony and Echo, depending on the particular effect applied.

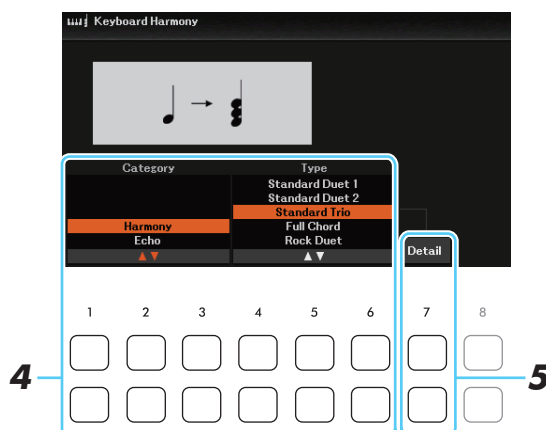

## ■ Harmony

The types from *Standard Duet 1* to *Strum* apply the harmony effect to notes played in the right-hand section of the keyboard according to the chord specified in the left-hand section of the keyboard. (Note that the “1+5” and “Octave” settings are not affected by the chord.) If you want to use these types with the Style stopped, set the *Stop ACMP* parameter to a setting other than *Disabled* in the *Style Setting* display (page 25).

- When the [ACMP] button is on and the Left part is off:

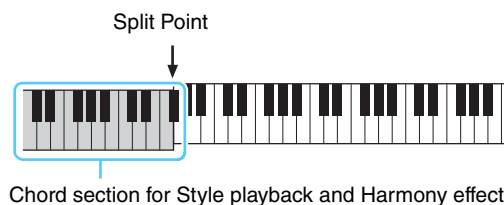

- When the [ACMP] button is off and the Left part is on:

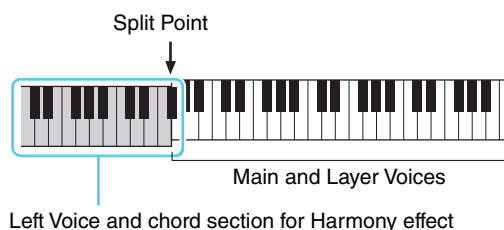

- When both the [ACMP] button and the Left part are on:

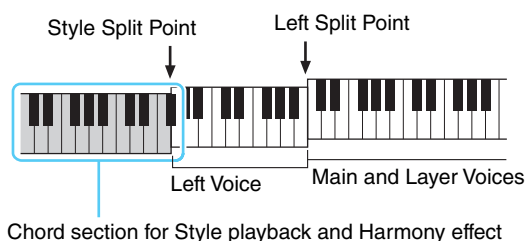

The *Multi Assign* effect automatically assigns notes played simultaneously on the right-hand section of the keyboard to separate parts (Voices). Both of the keyboard parts [MAIN] and [LAYER] should be turned on when using the *Multi Assign* effect. The Main and Layer Voices are alternately assigned to the notes in the order you play.

## ■ Echo

When *Echo*, *Tremolo* or *Trill* is selected, the corresponding effect (echo, tremolo, trill) is applied to the note played in the right-hand section of the keyboard in time with the currently set tempo, regardless of the [ACMP] and the Left part on/off status. Keep in mind that *Trill* only works when you hold down two notes on the keyboard simultaneously (last two notes if more than two notes are held), and it plays those notes alternately.



## 5 Use the [7 ▲▼] (*Detail*) buttons to call up the detail setting window, and then use the [3 ▲▼] – [8 ▲▼] buttons to make necessary settings.

The available settings differ depending on the Harmony type selected in step 4.

[3 ▲▼]	<i>Volume</i>	This parameter is available for all types with the exception of <i>Multi Assign</i> . It determines the level of the harmony/echo notes generated by the Harmony/Echo effect.
[4 ▲▼]/ [5 ▲▼]	<i>Assign</i>	This parameter is available for all types with the exception of <i>Multi Assign</i> . This lets you determine the keyboard part via which the harmony/echo notes will be sounded. <ul style="list-style-type: none"> <li>• <i>Auto</i>: Applies the effect to the part which is turned on. When the both parts are on, the Main part is given priority over the Layer part.</li> <li>• <i>Multi</i>: When both parts are on, the note played on the keyboard is sounded by Main part and the harmonies (effect) are divided to the Main and Layer parts. When only one part is on, the note played on the keyboard and effect are sounded by that part.</li> <li>• <i>Main, Layer</i>: Applies the effect to the selected part (Main or Layer).</li> </ul>
[6 ▲▼]	<i>Speed</i>	This parameter is only available when <i>Echo, Tremolo, or Trill</i> is selected in <i>Type</i> above. It determines the speed of the <i>Echo, Tremolo, and Trill</i> effects.
[7 ▲▼]	<i>Chord Note Only</i>	This parameter is available when one of the Harmony Types is selected. When this is set to <i>On</i> , the Harmony effect is applied only to notes (played in the right-hand section of the keyboard) that belong to a chord played in the chord section of the keyboard.
[8 ▲▼]	<i>Minimum Velocity</i>	This parameter is available for all types with the exception of <i>Multi Assign</i> . It determines the lowest velocity value at which the harmony note will sound. This allows you to selectively apply the harmony by your playing strength, letting you create harmony accents in the melody. The harmony effect is applied when you play the key strongly (above the set value).

## 6 Play the keyboard.

The effect selected in step 4 is applied to the right-hand melody.

# Pitch-Related Settings

## Fine-tuning the Pitch of the Entire Instrument

You can fine-tune the pitch of the entire instrument such as keyboard, Style and Song parts (except the keyboard part played by the Drum Kit or SFX Kit Voices, and audio playback)—a useful feature when playing this instrument along with other instruments or audio playback.

### 1 Call up the operation display.

[MENU] → Cursor buttons [▲][▼][◀][▶] *Master Tune/ Scale Tune*, [ENTER] → TAB [◀] *Master Tune*

### 2 Use the [4 ▲▼]/[5 ▲▼] (*Master Tune*) buttons to set the tuning in 0.2 Hz steps.

Press both [▲] and [▼] buttons (of 4 or 5) simultaneously to reset the value to the factory setting of 440.0 Hz.

## Scale Tuning

You can select various scales for playing in custom tunings for specific historical periods or music genres.

### 1 Call up the operation display.

[MENU] → Cursor buttons [▲][▼][◀][▶] *Master Tune/ Scale Tune*, [ENTER] → TAB [▶] *Scale Tune*

### 2 Use the [1 ▲▼] (*Type*) buttons to call up the *Scale Tune Type* window, and then use the [1 ▲▼]/[2 ▲▼] buttons to select the desired scale.

After selecting, press the [EXIT] button to close the window.

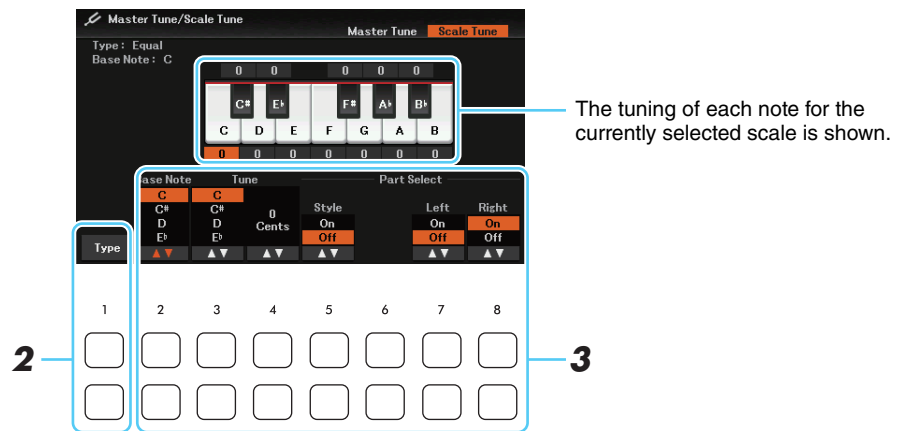

### ■ Preset Scale types

<i>Equal</i>	The pitch range of each octave is divided equally into twelve parts, with each half-step evenly spaced in pitch. This is the most commonly used tuning in music today.
<i>Pure Major, Pure Minor</i>	These tunings preserve the pure mathematical intervals of each scale, especially for triad chords (root, third, fifth). You can hear this best in actual vocal harmonies—such as choirs and a cappella singing.
<i>Pythagorean</i>	This scale was devised by the famous Greek philosopher and is created from a series of perfect fifths, which are collapsed into a single octave. The 3rd in this tuning are slightly unstable, but the 4th and 5th are beautiful and suitable for some leads.
<i>Mean-Tone</i>	This scale was created as an improvement on the Pythagorean scale, by making the major third interval more “in tune.” It was especially popular from the 16th century to the 18th century. Handel, among others, used this scale.

<b>Werckmeister, Kirnberger</b>	This composite scale combines the Werckmeister and Kirnberger systems, which were themselves improvements on the mean-tone and Pythagorean scales. The main feature of this scale is that each key has its own unique character. The scale was used extensively during the time of Bach and Beethoven, and even now it is often used when performing period music on the harpsichord.
<b>Arabic1, Arabic2</b>	Use these tunings when playing Arabic music.

### 3 Change the following settings as necessary.

[2 ▲▼]	<b>Base Note</b>	Determines the base note for each scale. When the base note is changed, the pitch of the keyboard is transposed, yet maintains the original pitch relationship between the notes.
[3 ▲▼]/ [4 ▲▼]	<b>Tune</b>	Select the desired note to be tuned by using the [3 ▲▼] buttons and tune it in cents by using the [4 ▲▼] buttons.  <b>NOTE</b> In musical terms a "cent" is 1/100th of a semitone. (100 cents equal one semitone.)
[5 ▲▼]– [8 ▲▼]	<b>Part Select</b>	Determines whether the Scale Tune setting is applied to each part or not.

**NOTE** If you want to store the Scale Tune settings to Registration Memory, be sure to checkmark *Scale Tune* in the *Registration Memory* display called up via the [MEMORY] button.

**NOTE** If a VRM Voice is selected as the Main part, the resonance of all VRM Voices is set to the same scale type as that of the Main part. If a Voice other than a VRM Voice is selected as the Main part, the resonance of any other VRM Voices is set to *Equal*.

## Pitch Settings for Each Keyboard Part

You can set the pitch independently for each keyboard part.

### 1 Call up the operation display.

[MENU] → Cursor buttons [▲][▼][◀][▶] *Voice Setting*, [ENTER] → TAB [◀][▶] *Tune*

### 2 Use the Cursor buttons [▲][▼] to select the item, and then use the [3 ▲▼] – [8 ▲▼] buttons to adjust the value for the corresponding part.

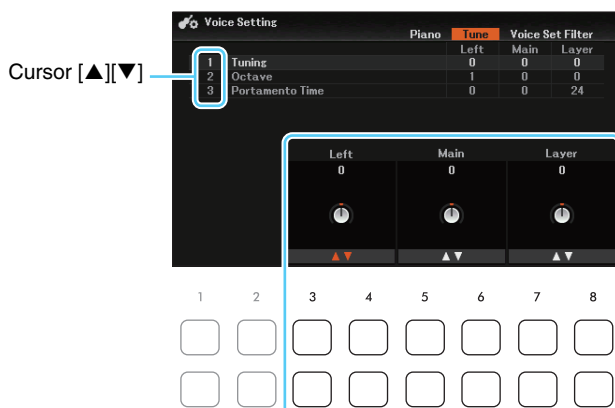

#### 1 Tuning

Determines the pitch of each keyboard part.

#### 2 Octave

Determines the range of the pitch change in octaves, over two octaves up or down for each keyboard part.

#### 3 Portamento Time

Portamento is a function that creates a smooth transition in pitch from the first note played on the keyboard to the next. The Portamento Time determines the pitch transition time. Higher values result in a longer pitch change time. Setting this to "0" results in no effect. This parameter is available when the selected keyboard part is set to *Mono* (page 13).

## Editing Voices (Voice Set)

The Voice Set function allows you to create your own Voices by editing some parameters of the existing Voices. Once you've created a Voice, you can save it as a file to internal memory (User drive) or a USB flash drive for future recall.

- 1 Select the desired Voice.
- 2 In the Voice Selection display, press the [5 ▼] (Voice Set) button to call up the Voice Set display.

**NOTE** If the button is not shown, press the [8 ▼] (Close) button to call it up.

- 3 Use the TAB [◀][▶] buttons to call up the relevant setting page.

For information on the available parameters in each page, see [page 13](#).

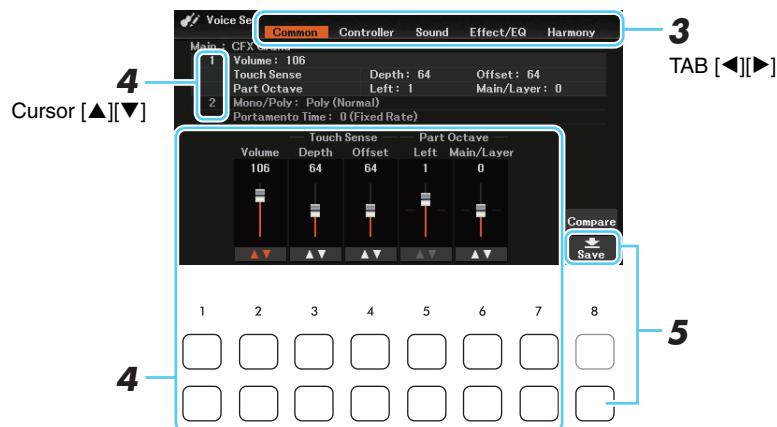

- 4 As necessary, use the Cursor buttons [▲][▼] to select the item (parameter) to be edited and edit the Voice by using the [1 ▲▼]–[7 ▲▼] buttons.

Pressing the [8 ▲] (Compare) button toggles the sound between the edited Voice and original (unedited) Voice to let you compare the sound played on the keyboard.

- 5 Press the [8 ▼] (Save) button to save your edited Voice.

For details on the Save operation, refer to “Basic Operations” in the Owner’s Manual.

### **NOTICE**

The settings will be lost if you select another Voice or turn off the power to the instrument without carrying out the Save operation.

# Editable Parameters in the Voice Set Displays

The Voice Set parameters are organized into five different pages. The parameters in each page are described separately, below.

**NOTE** The available parameters differ depending on the Voice.

## Common page

### 1 Volume, Touch Sense, Part Octave

[2 ▲▼]	<b>Volume</b>	Adjusts the volume of the current edited Voice.
[3 ▲▼]/ [4 ▲▼]	<b>Touch Sense</b>	<p>Adjusts the touch sensitivity (velocity sensitivity), or how greatly the volume responds to your playing strength.</p> <div style="display: flex; justify-content: space-around;"> <div data-bbox="606 571 941 996"> <p><b>Touch Sense Depth</b> Changes to velocity curve according to VelDepth (with Offset set to 64)</p> </div> <div data-bbox="973 571 1372 1108"> <p><b>Touch Sense Offset</b> Changes to velocity curve according to VelOffset (with Depth set to 64)</p> </div> </div> <ul style="list-style-type: none"> <li>• <b>Depth:</b> Determines the velocity sensitivity, or how much the level of the Voice changes in response to your playing strength (velocity).</li> <li>• <b>Offset:</b> Determines the amount by which received velocities are adjusted for the actual velocity effect.</li> </ul>
[5 ▲▼]/ [6 ▲▼]	<b>Part Octave</b>	Shifts the octave range of the edited Voice up or down in octaves. When the edited Voice is used as any of the Main and Layer parts, the <b>Main/Layer</b> parameter is available; when the edited Voice is used as the Left part, the <b>Left</b> parameter is available.

### 2 Mono/Poly, Portamento

[1 ▲▼]/ [2 ▲▼]	<b>Mono/Poly</b>	Determines whether the edited Voice is played monophonically ( <b>Mono</b> ) or polyphonically ( <b>Poly</b> ).
[3 ▲▼]/ [4 ▲▼]	<b>Mono Type</b>	<p>Determines the behavior of the notes of decaying sounds, such as a guitar, when they are played with legato with the edited Voice set to <b>Mono</b> above.</p> <ul style="list-style-type: none"> <li>• <b>Normal:</b> The next note sounds after the previous note is stopped.</li> <li>• <b>Legato:</b> The sound of the previously played note is maintained and only the pitch changes to that of the next note.</li> <li>• <b>Crossfade:</b> The sound smoothly transitions from the previously played note to the next note.</li> </ul> <p><b>NOTE</b> This parameter is unavailable for Super Articulation Voices and Drum/SFX Kit Voices, and behaves the same as the <i>Normal</i> setting when these Voices are selected.</p> <p><b>NOTE</b> When <i>Legato</i> is selected, the behavior (other than what is described here) may be different from <i>Normal</i>, depending on the panel settings.</p>

[5 ▲▼]	<b>Portamento Time</b>	Determines the pitch transition time when the edited Voice is set to <i>Mono</i> above.  <b>NOTE</b> Portamento is a function that creates a smooth transition in pitch from the first note played on the keyboard to the next.
[6 ▲▼]/ [7 ▲▼]	<b>Portamento Type</b>	Determines how an actual pitch transition time is calculated from the <b>Portamento Time</b> value above.  <ul style="list-style-type: none"> <li>• <b>Fixed Rate:</b> Make the pitch change rate to 0: max., 127: min. The actual pitch transition time varies according to the interval between the two notes.</li> <li>• <b>Fixed Time:</b> Make the actual pitch transition time to 0: min., 127: max. The pitch change rate varies according to the interval between the two notes.</li> </ul> <b>NOTE</b> The basic rule of Portamento Time is unchanged even if this setting is changed. When the value of Portamento Time is smaller, the actual time is shorter; when the value is larger, the actual time is longer.  <b>NOTE</b> The greater the value of Portamento Time, the clearer the effect of this setting will be.

### ■ Controller page

#### 1 Center Pedal, 2 Left Pedal

These allow you to select the function to be assigned to the center or left pedal of the pedal unit (sold separately) connected to the [PEDAL UNIT] jack.

[1 ▲▼]	<b>Function</b>	Selects the function to be assigned to the center or left pedal. For details on the pedal functions, see <a href="#">page 76</a> .
[2 ▲▼]– [7 ▲▼]	<b>Main, Layer, Left, etc.</b>	Determines whether the assigned function is effective or not for the respective keyboard part. Depending on the selected function above, the related parameters such as depth can be set. For details, see the pedal function list on <a href="#">page 76</a> .

#### 3 Modulation

When a pedal function is set to **Modulation** ([page 77](#)), the pedal can be used to modulate the parameters below as well as the pitch (vibrato). Here, you can set the degree to which the pedal modulates each of the following parameters.

[2 ▲▼]	<b>Filter</b>	Determines the degree to which the pedal modulates the Filter Cutoff Frequency. For details about the filter, see below.
[3 ▲▼]	<b>Amplitude</b>	Determines the degree to which the pedal modulates the amplitude (volume).
[5 ▲▼]	<b>LFO PMOD</b>	Determines the degree to which the pedal modulates the pitch, or the vibrato effect.
[6 ▲▼]	<b>LFO FMOD</b>	Determines the degree to which the pedal modulates the Filter modulation, or the wah effect.
[7 ▲▼]	<b>LFO AMOD</b>	Determines the degree to which the pedal modulates the amplitude, or the tremolo effect.

■ **Sound page**

**1 Filter, EG**

• **Filter**

Filter is a processor that changes the timbre or tone of a sound by either blocking or passing a specific frequency range. The parameters below determine the overall timbre of the sound by boosting or cutting a certain frequency range. In addition to making the sound either brighter or mellower, Filter can be used to produce electronic, synthesizer-like effects.

[2 ▲▼]	<b>Brightness</b>	Determines the cutoff frequency or effective frequency range of the filter (see diagram). Higher values result in a brighter sound.	
[3 ▲▼]	<b>Harmonic Content</b>	Determines the emphasis given to the cutoff frequency (resonance), set in <b>Brightness</b> above (see diagram). Higher values result in a more pronounced effect.	

• **EG**

The EG (Envelope Generator) settings determine how the level of the sound changes in time. This lets you reproduce many sound characteristics of natural acoustic instruments—such as the quick attack and decay of percussion sounds, or the long release of a sustained piano tone.

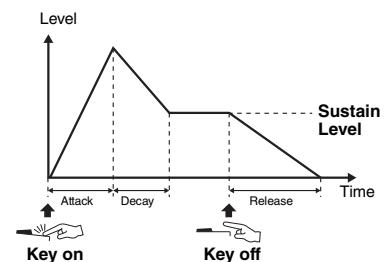

[4 ▲▼]	<b>Attack</b>	Determines how quickly the sound reaches its maximum level after the key is played. The lower the value, the quicker the attack.
[5 ▲▼]	<b>Decay</b>	Determines how quickly the sound reaches its sustain level (a slightly lower level than maximum). The lower the value, the quicker the decay.
[6 ▲▼]	<b>Release</b>	Determines how quickly the sound decays to silence after the key is released. The lower the value, the quicker the decay.

**2 Vibrato**

Vibrato is a quavering, vibrating sound effect that is produced by regularly modulating the pitch of the Voice.

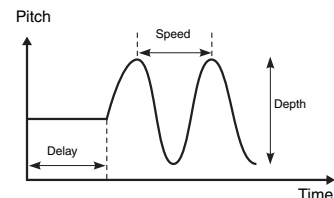

[3 ▲▼]	<b>Depth</b>	Determines the intensity of the Vibrato effect. Higher settings result in a more pronounced Vibrato.
[4 ▲▼]	<b>Speed</b>	Determines the speed of the Vibrato effect.
[5 ▲▼]	<b>Delay</b>	Determines the amount of time that elapses between the playing of a key and the start of the Vibrato effect. Higher settings increase the delay of the Vibrato onset.

## ■ *Effect/EQ* page

### 1 Reverb Depth, Chorus Depth, DSP Depth, Vibe Rotor

[1 ▲▼]/ [2 ▲▼]	<i>Reverb Depth</i>	Adjusts the reverb depth. The setting cannot be changed when a VRM Voice is selected.
[3 ▲▼]/ [4 ▲▼]	<i>Chorus Depth</i>	Adjusts the chorus depth. The setting cannot be changed when a VRM Voice is selected.
[5 ▲▼]	<i>DSP On/Off</i>	Determines whether the DSP effect is on or off.
[6 ▲▼]	<i>DSP Depth</i>	Adjusts the DSP depth. If you want to re-select the DSP type, you can do so in the <b>2 DSP</b> menu explained below.
[7 ▲▼]	<i>Vibe Rotor</i>	This will be displayed only if <i>Vibe Rotor</i> is selected for the DSP Type parameter explained below. Determines whether <i>Vibe Rotor</i> should be set to on or off when selecting a Voice.

### 2 DSP Type

[2 ▲▼]/ [3 ▲▼]	<i>Category</i>	Selects the DSP effect category and type. Select a type after selecting a category.
[4 ▲▼]/ [5 ▲▼]	<i>Type</i>	
[6 ▲▼]	<i>Detail</i>	Calls up a detailed setting display. In the detailed setting display, select the desired parameter by using the [2 ▲▼] – [4 ▲▼] buttons, and then adjust the value by using the [5 ▲▼] / [6 ▲▼] buttons. This differs depending on the effect type and cannot be changed. Press the [EXIT] button to close the setting display.

### 3 EQ

Determines the Frequency and Gain of the Low and High EQ bands. For information about EQ, refer to [page 71](#).

## ■ *Harmony* page

From this display, you can set the same parameters as those in the *Keyboard Harmony* display (step 4 on [page 7](#)). Before making any settings, make sure that the current part is set to Main; in other words, you should turn on the Main part by pressing the PART ON/OFF [MAIN] button. The settings here are called up automatically simply by selecting the corresponding Voice.



## Disabling Automatic Selection of Voice Sets (Effects, etc.)

Each Voice is linked to its default Voice Set parameter settings, equivalent to those in the *Voice Set* display (page 12). Although usually these settings are automatically called up by selecting a Voice, you can also disable this feature. For example, if you want to change the Voice yet keep the same effect, set the *Effect* parameter for the desired keyboard part to *Off*.

### 1 Call up the operation display.

[MENU] → Cursor buttons [▲][▼][◀][▶] *Voice Setting*, [ENTER] → TAB [▶] *Voice Set Filter*

### 2 Use the Cursor buttons [▲][▼] to select the parameter group to be set.

Each item corresponds to the following parameters in the *Voice Set* display (page 12).

- **1 Voice:** Parameter settings of *Common* and *Sound* pages
- **2 Effect:** Parameter settings of 1 and 2 in the *Effect/EQ* page
- **3 EQ:** Parameter settings of 3 in the *Effect/EQ* page
- **4 Keyboard Harmony:** Parameter settings of *Harmony* page
- **5 Pedal:** Parameter settings of *Controller* page

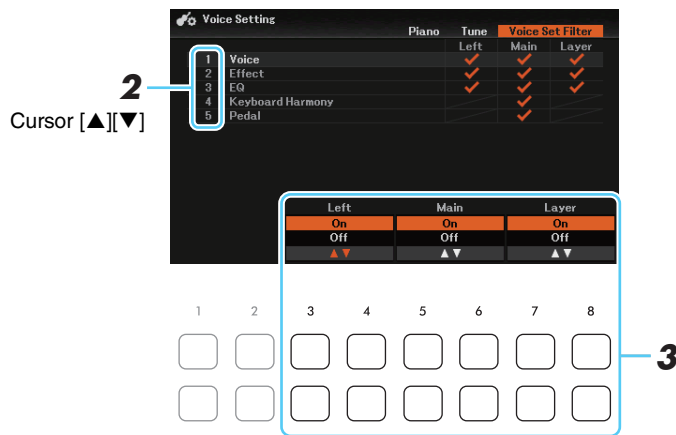

### 3 Use the [3 ▲▼]–[8 ▲▼] buttons to determine whether the parameter selected in step 2 is called up (On) or not (Off) for each keyboard part.

For each keyboard part, only the parameter settings with checkmarks are called up automatically together with the Voice selection.

## Contents

<b>Playing Style with the Smart Chord feature</b> .....	<b>19</b>
• Smart Chord Chart .....	21
<b>Learning How To Play Specific Chords (Chord Tutor)</b> .....	<b>21</b>
<b>Chord Types Recognized in Fingered</b> .....	<b>22</b>
<b>Style Playback Related Settings</b> .....	<b>23</b>
<b>Specifying Chords with Your Right Hand while Playing Bass with Your Left Hand</b> .....	<b>25</b>
<b>Creating/Editing Styles (Style Creator)</b> .....	<b>26</b>
• Basic Procedure for Creating a Style .....	26
• Realtime Recording .....	28
• Assigning the Source Pattern to Each Channel (Assembly) .....	32
• Editing the Rhythmic Feel (Groove) .....	34
• Editing Data for Each Channel (Channel) .....	36
• Making Style File Format Settings (Parameter) .....	37
• Editing the Rhythm Part of a Style (Drum Setup) .....	41

### Style Types (Characteristics)

The particular type of Style is indicated above (or in the icon at the left of) the Style name on the Style Selection display or the Main display. The defining characteristics of these Styles and their performance advantages are described below.



- **Adaptive:** These Styles can be used with the Adaptive Style function in which the Main variation changes automatically depending on how dynamically you play the keyboard—without your needing to press the MAIN VARIATION buttons. For details, refer to the Owner’s Manual.
- **Unison:** These Styles can be used with the Unison & Accent function, which lets you play in unison and/or add accents during Style playback. For details, refer to the Owner’s Manual.
- **Session:** These Styles provide even greater realism and authentic backing by mixing in original chord types and changes, as well as special riffs with chord changes, with the Main sections. These have been programmed to add “spice” and a professional touch to your performances of certain songs and in certain genres. Keep in mind, however, that the Styles may not necessarily be appropriate—or even harmonically correct—for all songs and for all chord playing. In some cases for example, playing a simple major triad for a country song may result in a “jazzy” seventh chord, or playing an on-bass chord may result in inappropriate or unexpected accompaniment.
- **Pianist:** These special Styles provide piano-only accompaniment. Just by playing the proper chords with your left hand, you can automatically add complicated, professional-sounding arpeggios and bass/chord patterns.

## Playing Style with the Smart Chord feature

If you want to fully enjoy playing in various Styles but don't know how to play the appropriate chords, set the Chord Fingering type to **Smart Chord**. This lets you control Styles with just a single finger, as long as you know the key of the music you're playing—even if you don't know any chord fingering such as major, minor, diminished and so on. Appropriate chords suited for the music genre will sound whenever you press a single note, as if you were playing the “right” chords.

Try out the Smart Chord feature with the following sample score. Simply play the root notes of the chords indicated in this score with your left hand as you play the melody with your right hand, and listen to how the chords with their notes and voicings match the music genre you've set.

### ■ “Home Sweet Home”

Chord section

- Style: **70sPopDuo**
- Key Signature: **F Major (♭\*1)**
- Type: **Standard**

Key Signature (Key in F major)

Chord Types

Try also selecting Style **Easy Swing** (via the [STANDARDS & JAZZ] button) by using this score. The Smart Chord type changes to **Jazz**, letting you experience a different feel in the Song.

## 1 Select the desired Style and make sure that the STYLE CONTROL [ACMP] button is on (the lamp is lit).

For the example score, press the [BALLAD] button, and then select *70sPopDuo*.

## 2 Call up the operation display.

[MENU] → Cursor buttons [▲][▼][◀][▶] *Split Point/Chord Fingering*, [ENTER] → TAB [▶] *Chord Fingering*

## 3 Use the [2 ▲▼] – [4 ▲▼] (*Fingering Type*) buttons to select Smart Chord.

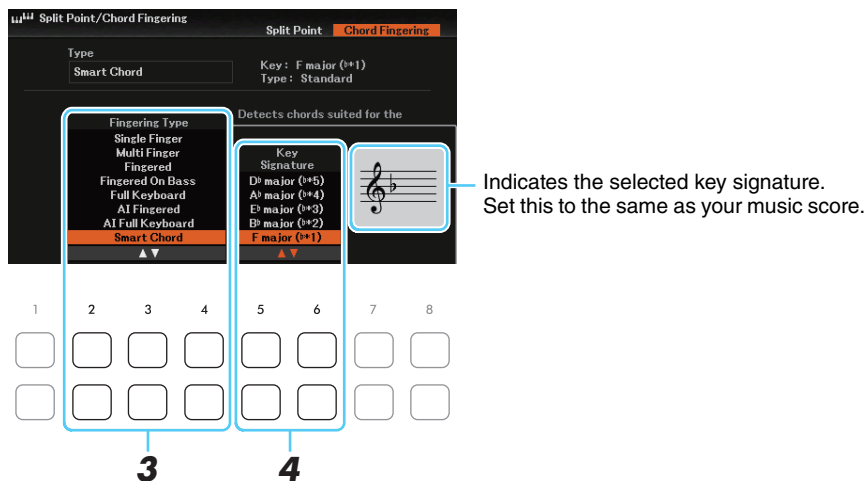

## 4 Use the [5 ▲▼] / [6 ▲▼] (*Key Signature*) buttons to select the key signature.

Make sure to select the key signature which is same as that on your music score, or your desired key for playing.

For the example score, select *F Major (b\*1)*.

After selecting, press the [EXIT] button to close the window.

## 5 Use the [7 ▲▼] / [8 ▲▼] (*Type*) buttons to select the type of music genre.

The type selected here determines the specific chord assignment for each scale note in the Chord section. Although selecting a Style in step 1 will automatically set the optimum type, you can select a different type here for more appropriate results, if necessary.

For the example score, select *Standard*.

**NOTE** Each music type assumes only typical or conventional chord progression for the Style.

**NOTE** Examples of the chord assignments are provided in the Smart Chord Chart on page 21.

## 6 Press the STYLE CONTROL [SYNC START] button to enable synchronized start.

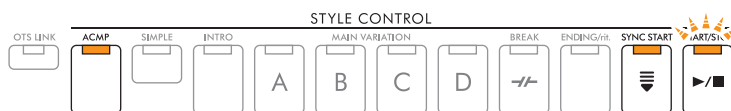

## 7 According to the music score or the chord progression of your performance, play only the root key with the left hand.

Pressing a key will start playback of the Style.

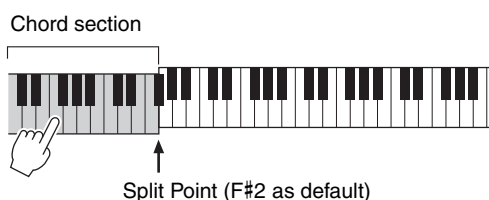

# Smart Chord Chart

This chart shows how the chord is played when you simply press the root note of chord in C major or A minor for each *Type*. The chord changes depending on the selected *Type* and *Key Signature*. Examples of F major for Pop and E minor for Jazz are also shown below.

Smart Chord setting		Root Note											
		C	C#	D	D#	E	F	F#	G	G#	A	A#	B
Type	Key Signature	↓	↓	↓	↓	↓	↓	↓	↓	↓	↓	↓	↓
<b>Standard</b>	C major	C	C#dim	Dm	E♭	Em	F	F#dim	G7	G#dim	Am	B♭	G/B
	A minor	C	C#dim	Dm	D#dim7	E7	F	F#dim	G7	E7/G#	Am	B♭	Bm7 <sup>b5</sup>
<b>Pop</b>	C major	Cadd9	C#dim7	Dm7	E♭dim7	Em7	FM7	F#dim	G7	G#dim	Am7	B♭	G/B
	A minor	C	C#dim7	Dm7	D#dim7	E7	FM7	F#dim	G7	E7/G#	Am7	B♭	G/B
<b>Jazz</b>	C major	CM7 <sup>9</sup>	C#dim7	Dm7 <sup>9</sup>	E♭dim7	Em7	F6 <sup>9</sup>	F#dim7	G7 <sup>9</sup>	G#dim	Am7 <sup>11</sup>	B♭7	Bm7 <sup>b5</sup>
	A minor	CM7 <sup>9</sup>	C#dim7	Dm7 <sup>9</sup>	D#dim7	E7	FM7 <sup>9</sup>	F#m7 <sup>b5</sup>	G7 <sup>9</sup>	G#7	Am <sup>add9</sup>	B♭7	Bm7 <sup>b5</sup>
<b>Dance</b>	C major	C	C#dim	Dm	E♭	Em	F	F#dim	G	G#dim	Am	B♭	G/B
	A minor	Cm	C#m	Dm	D#m	Em	Fm	F#m	Gm	G#	Am	B♭	Bm
<b>Simple</b>	C major	C	C#dim	Dm	E♭	E1+5	F1+5	F#dim	G7	G#dim	Am	B♭	G/B
	A minor	C	C#dim	Dm	D#dim7	E1+5	F	F#dim	G7	E7/G#	Am	B♭	Bm7 <sup>b5</sup>

Example chords for key of F major, Pop Type setting.

<b>Pop</b>	F major	C7	C#dim	Dm7	E♭	C/E	Fadd9	F#dim7	Gm7	A♭dim7	Am7	B♭M7	Bdim
------------	---------	----	-------	-----	----	-----	-------	--------	-----	--------	-----	------	------

Example chords for key of E minor, Jazz Type setting.

<b>Jazz</b>	E minor	CM7 <sup>9</sup>	C#m7 <sup>b5</sup>	D7 <sup>9</sup>	D#7	Em <sup>add9</sup>	F7	F#m7 <sup>b5</sup>	GM7 <sup>9</sup>	G#dim7	Am7 <sup>9</sup>	A#dim7	B7
-------------	---------	------------------	--------------------	-----------------	-----	--------------------	----	--------------------	------------------	--------	------------------	--------	----

## Learning How To Play Specific Chords (Chord Tutor)

If you know the name of a chord but don't know how to play it, the Chord Tutor function conveniently shows you which notes to play.

### 1 Call up the operation display.

[MENU] → Cursor buttons [▲][▼][◀][▶] *Chord Tutor*, [ENTER]

### 2 Use the [1 ▲▼] / [2 ▲▼] (Root) buttons to select the chord root, and use the [3 ▲▼] / [4 ▲▼] (Type) buttons to select the chord type.

The notes you need to play are shown in the display.

**NOTE** Depending on the chord, some notes may be omitted.

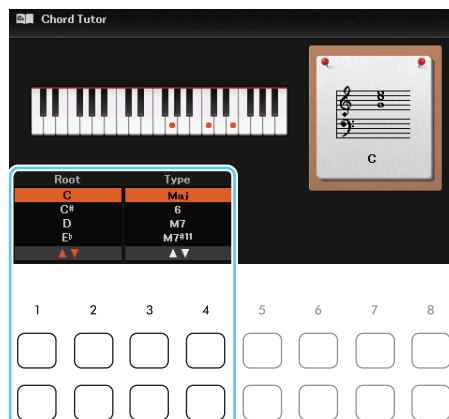

# Chord Types Recognized in Fingered

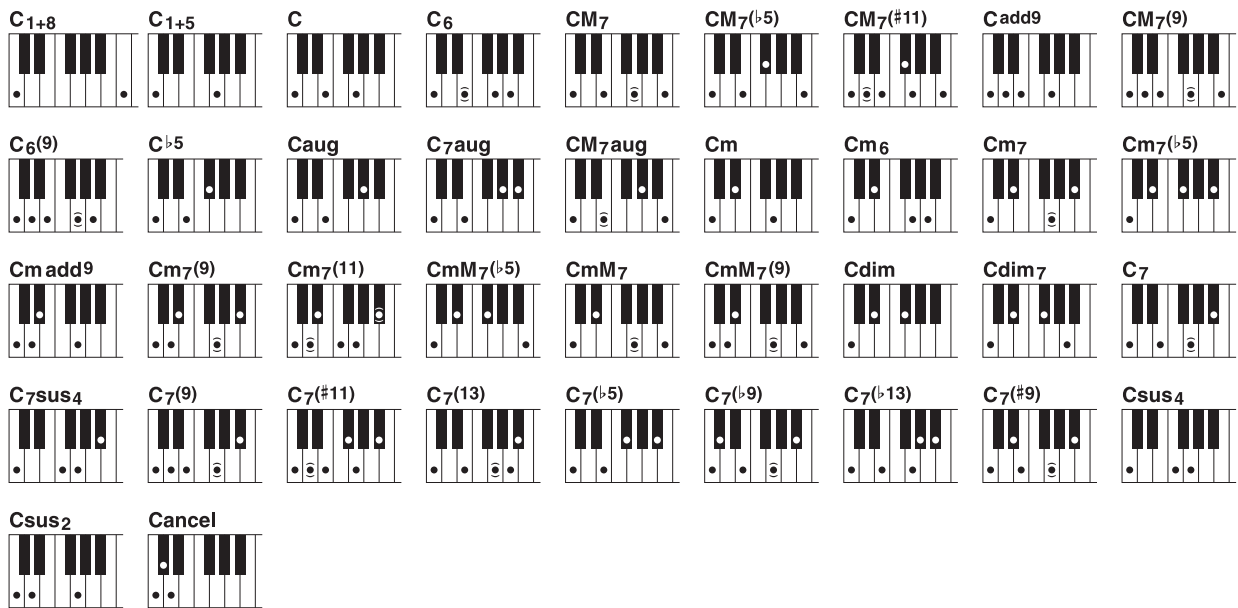

Chord Name [Abbreviation]	Normal Voicing*	Display for root "C"
1+8	1+8	C1+8
1+5	1+5	C1+5
Major [M]	1+3+5	C
Sixth [6]	1+(3)+5+6	C6
Major seventh [M7]	1+3+(5)+7	CM7
Major seventh flatted fifth [M7b5]	1+3+b5+7	CM7(b5)
Major seventh add sharp eleventh [M7(#11)]	1+(2)+3+#4+5+7	CM7(#11)
Add ninth [add9]	1+2+3+5	Cadd9
Major seventh ninth [M7_9]	1+2+3+(5)+7	CM7(9)
Sixth ninth [6_9]	1+2+3+(5)+6	C6(9)
Flatted fifth [(b5)]	1+3+b5	Cb5
Augmented [aug]	1+3+#5	Caug
Seventh augmented [7aug]	1+3+#5+b7	C7aug
Major seventh augmented [M7aug]	1+(3)+#5+7	CM7aug
Minor [m]	1+b3+5	Cm
Minor sixth [m6]	1+b3+5+6	Cm6
Minor seventh [m7]	1+b3+(5)+b7	Cm7
Minor seventh flatted fifth [m7b5]	1+b3+b5+b7	Cm7(b5)
Minor add ninth [m(9)]	1+2+b3+5	Cm add9
Minor seventh ninth [m7(9)]	1+2+b3+(5)+b7	Cm7(9)
Minor seventh eleventh [m7(11)]	1+(2)+b3+4+5+(b7)	Cm7(11)
Minor major seventh flatted fifth [mM7b5]	1+b3+b5+7	CmM7(b5)
Minor major seventh [mM7]	1+b3+(5)+7	CmM7
Minor major seventh ninth [mM7(9)]	1+2+b3+(5)+7	CmM7(9)
Diminished [dim]	1+b3+b5	Cdim
Diminished seventh [dim7]	1+b3+b5+6	Cdim7
Seventh [7]	1+3+(5)+b7	C7
Seventh suspended fourth [7sus4]	1+4+5+b7	C7sus4
Seventh ninth [7(9)]	1+2+3+(5)+b7	C7(9)
Seventh add sharp eleventh [7(#11)]	1+(2)+3+#4+5+b7	C7(#11)
Seventh add thirteenth [7(13)]	1+3+(5)+6+b7	C7(13)
Seventh flatted fifth [7b5]	1+3+b5+b7	C7(b5)
Seventh flatted ninth [7(b9)]	1+b2+3+(5)+b7	C7(b9)
Seventh add flatted thirteenth [7(b13)]	1+3+5+b6+b7	C7(b13)
Seventh sharp ninth [7(#9)]	1+#2+3+(5)+b7	C7(#9)
Suspended fourth [sus4]	1+4+5	Csus4
One plus two plus five [sus2]	1+2+5	Csus2
cancel	1+b2+2	Cancel

**NOTE** Notes in parentheses can be omitted.

**NOTE** The "cancel" indication refers to Chord Cancel, which stops the last selected chord from playing and leaves only the drums/rhythm.

# Style Playback Related Settings

The instrument has a variety of settings for Style playback which can be accessed in the display below.

## 1 Call up the operation display.

[MENU] → Cursor buttons [▲][▼][◀][▶] *Style Setting*, [ENTER] → TAB [◀][▶] *Setting1* or *Setting2*

## 2 Use the Cursor buttons [▲][▼] to select the page, and then use the corresponding [1 ▲▼]–[8 ▲▼] buttons for each setting.

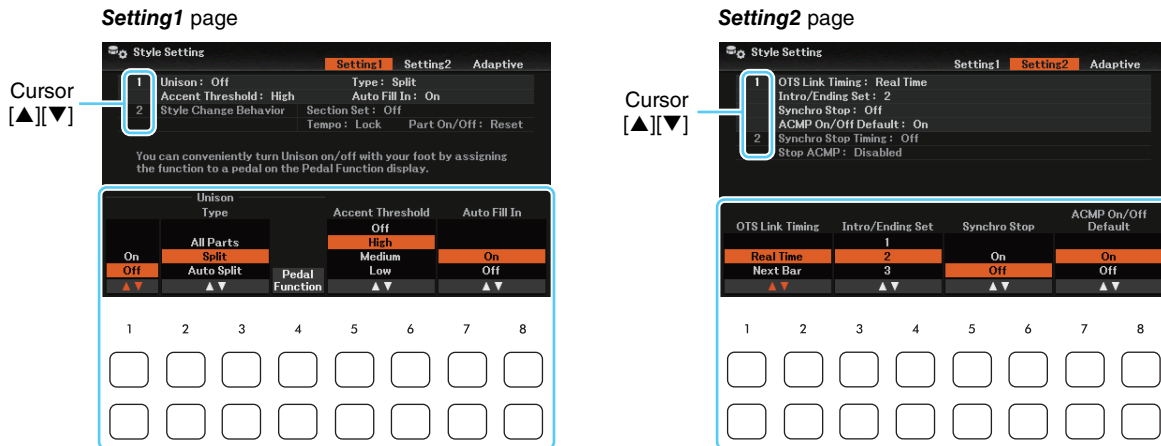

### ■ Setting1 page

#### 1 Unison & Accent, Auto Fill-in

[1 ▲▼]– [6 ▲▼]	These are used for the Unison & Accent function. Refer to the Owner's Manual, Chapter 3.	
[7 ▲▼]/ [8 ▲▼]	<b>Auto Fill In</b>	When this is set to <b>On</b> , pressing any of the MAIN VARIATION [A] – [D] buttons as you play automatically plays a fill-in section.

#### 2 Style Change Behavior

[2 ▲▼]/ [3 ▲▼]	<b>Section Set</b>	Determines the default section that is automatically called up when selecting different Styles (when Style playback is stopped). When set to <b>Off</b> and Style playback is stopped, the active section is maintained even if the different Style is selected. When any of the Main A–D sections is not included in the Style data, the nearest section is automatically selected. For example, when Main D is not contained in the selected Style, Main C will be called up.
[4 ▲▼]/ [5 ▲▼]	<b>Tempo</b>	This determines whether the tempo setting of the Style changes or not when you change Styles. <ul style="list-style-type: none"> <li>• <b>Lock:</b> The previous tempo setting is always maintained. When the Style tempo is locked to the previous setting, a padlock icon appears above the Style name on the Main display.</li> <li>• <b>Hold:</b> During Style playback, the previous tempo setting is maintained. When Style playback is stopped, the tempo changes to that of the initial default tempo for the selected Style.</li> <li>• <b>Reset:</b> The tempo always changes to that of the initial default tempo for the selected Style.</li> </ul>

[6 ▲▼]/ [7 ▲▼]	<b>Part On/Off</b>	This determines whether the Style Channel On/Off status changes or not when you change Styles. <ul style="list-style-type: none"> <li>• <b>Lock:</b> The Channel On/Off status of the previous Style is always maintained.</li> <li>• <b>Hold:</b> During Style playback, the Channel On/Off status of the previous Style is maintained. When Style playback is stopped, all Style Channels are set to On.</li> <li>• <b>Reset:</b> All Style Channels are set to On.</li> </ul>
-------------------	--------------------	--

## ■ Setting2 page

### 1 OTS Link Timing, Intro/Ending, Synchro Stop, ACMP On/Off

[1 ▲▼]/ [2 ▲▼]	<b>OTS Link Timing</b>	This applies to the OTS Link function. This parameter determines the timing in which the One Touch Settings change with the MAIN VARIATION [A]–[D] change. (The [OTS LINK] button must be on.) <ul style="list-style-type: none"> <li>• <b>Real Time:</b> One Touch Setting is immediately called up when you press MAIN VARIATION [A]–[D] buttons.</li> <li>• <b>Next Bar:</b> One Touch Setting is called up at the next measure, after you press MAIN VARIATION [A]–[D] buttons.</li> </ul>
[3 ▲▼]/ [4 ▲▼]	<b>Intro/Ending Set</b>	Three different types of Intro/Ending sections are provided for each Style. This selects the Intro/Ending type. <p><b>NOTE</b> The Intro 1 section consists of only the Rhythm part while Intro 2 and 3 consist of all the parts as well as the Rhythm part. When you play Intro 2 or 3, in order to have the complete Intro section sound properly, you need to play chords in the chord section with the [ACMP] turned on.</p> <p><b>NOTE</b> When 1 is selected here, if you press the [ENDING/rit.] button while the Style is playing, a fill-in automatically plays before the Ending section.</p>
[5 ▲▼]/ [6 ▲▼]	<b>Synchro Stop</b>	Turns the Synchro Stop function on/off. When this is set to <b>On</b> , you can start the Style anytime you want by simply playing the keys in the chord section of the keyboard, and stop the Style by releasing them. To use this function, make sure that the [ACMP] button is on. <p><b>NOTE</b> When the Chord Fingering type is set to <i>Full Keyboard</i> or <i>All Full Keyboard</i>, or when the Unison function is turned on, <i>Synchro Stop</i> cannot be turned on.</p>
[7 ▲▼]/ [8 ▲▼]	<b>ACMP On/Off Default</b>	Determines whether the [ACMP] button is on or off when the power is turned on.

### 2 Synchro Stop Timing, Stop ACMP

[3 ▲▼]/ [4 ▲▼]	<b>Synchro Stop Timing</b>	This determines how long you can hold a chord before the Synchro Stop function is automatically canceled. When <b>Synchro Stop</b> above is set to <b>On</b> , and this is set to a value other than <b>Off</b> , this automatically cancels the Synchro Stop function if you hold a chord for longer than the time set here. This conveniently resets Style playback control to normal, letting you release the keys and still have the Style play. In other words, if you release the keys sooner than the time set here, the Synchro Stop function works.
-------------------	----------------------------	--



<p>[5 ▲▼]/ [6 ▲▼]</p>	<p><b>Stop ACMP</b></p>	<p>When the [ACMP] button is turned on and the [SYNC START] button is off, you can play chords in the chord section of the keyboard with the Style stopped, and still hear the accompaniment chord. In this condition—called “Stop Accompaniment”—any valid chord fingerings are recognized, and the chord root/type are shown in the display. Here, you can determine whether the chord played in the chord section will sound or not in the Stop Accompaniment status.</p> <ul style="list-style-type: none"> <li>• <b>Disabled:</b> Disables the Stop Accompaniment feature. When Style playback is stopped, any pressed notes in the chord section of the keyboard will not be recognized as chords.</li> <li>• <b>Off:</b> The chord played in the chord section will not sound.</li> <li>• <b>Style:</b> The chord played in the chord section will sound via the Voices for the Pad channel and the Bass channel of the selected Style.</li> <li>• <b>Fixed:</b> The chord played in the chord section will sound via the specified Voice, regardless of the selected Style.</li> </ul> <p><b>NOTE</b> When the selected Style contains MegaVoices, unexpected sounds may result when this is set to Style.</p> <p><b>NOTE</b> If you record a Song using the Stop Accompaniment, both the Voice that is sounded and the chord data will be recorded when set to Style, and only the chord data will be recorded when set to <i>Off</i> or <i>Fixed</i>.</p> <p><b>NOTE</b> When this is set to <i>Disabled</i>, chords are not recognized while the Style is stopped. For this reason, Keyboard Harmony is not applied even if you play a chord in the chord section of the keyboard while the Style is stopped.</p>
---------------------------	-------------------------	--

## Specifying Chords with Your Right Hand while Playing Bass with Your Left Hand

By changing the Chord Detection Area from the left-hand section to the right-hand section, you can play a bass line with your left hand while using your right hand to play chords for controlling Style playback.

### 1 Call up the operation display.

[MENU] → Cursor buttons [▲][▼][◀][▶] *Split Point/Chord Fingering*, [ENTER] → TAB [◀] *Split Point*

### 2 Use the [2 ▲▼]/[3 ▲▼] (*Chord Detection Area*) buttons to set to *Upper*.

The whole right-hand (*Upper*) section functions as the Chord section as well as for melody performance. Fingering type is set to *Fingered\** and *Manual Bass* (see below) is set to *On* automatically.

**NOTE** When the Chord Detection Area is set to *Upper*, only *Fingered\** is available. This type is basically same as *Fingered*, except that “1+5,” “1+8” and Chord Cancel are not available.

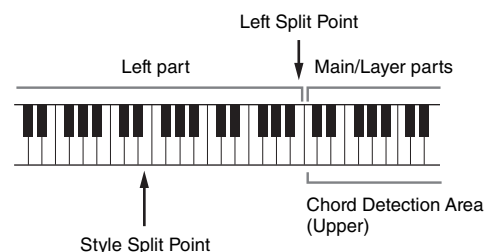
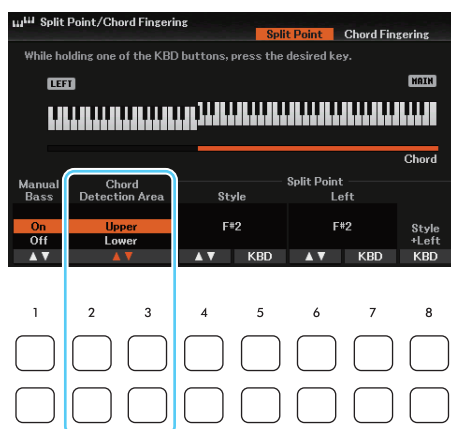

By using the [1 ▲▼] (*Manual Bass*) buttons, you can turn the Manual Bass function on/off. When this is set to *On*, the Voice for the bass part of the current Style is muted and assigned to the Left part.

**NOTE** This parameter is effective only when the *Chord Detection Area* is set to *Upper*.

## Creating/Editing Styles (Style Creator)

The Style Creator function lets you create original Styles by recording rhythm patterns from the keyboard and using already-recorded Style data. Basically, select a preset Style that is closest to the type you want to create, and then record the rhythm pattern, bass line, chord backing, or phrase (referred to as “Source Pattern” in the Style Creator) for each channel of each Section.

### ■ Style Data Structure — Source Patterns

A Style is made up of the different Sections (Intro, Main, Ending, etc.) and each Section has eight separate channels, each of which is referred to as “Source Pattern.” With the Style Creator feature, you can create a Style by separately recording the Source Pattern for each channel, or by importing pattern data from other existing Styles.

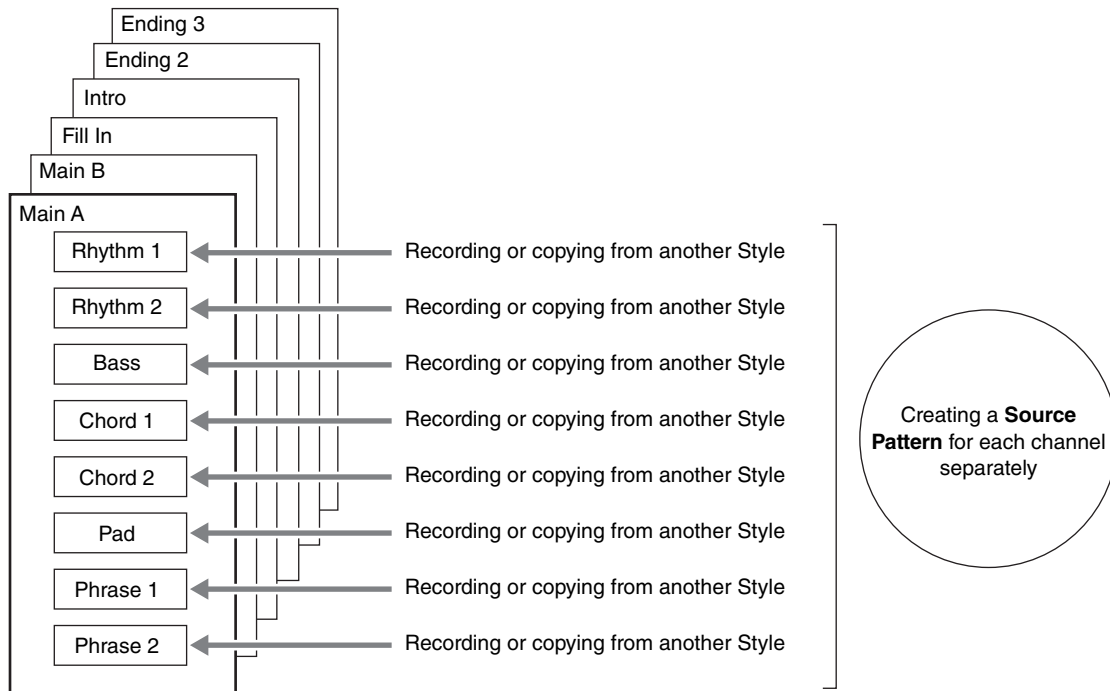

## Basic Procedure for Creating a Style

**1** Select the desired Style to be used as the basis for the new Style.

**2** Call up the Style Creator display.

[MENU] → Cursor buttons [▲][▼][◀][▶] *Style Creator*, [ENTER]

A message appears asking if you want to edit the selected style or create a new one.

**3** Press one of the [5 ▲▼]/[6 ▲▼] (*Current Style*) buttons to edit the selected Style, or press one of the [7 ▲▼]/[8 ▲▼] (*New Style*) buttons to create a new Style.

When one of the [7 ▲▼]/[8 ▲▼] buttons is pressed, a blank Style (named “NewStyle”) for recording is automatically created.

**4** From the *Basic* page, select a Section.

(If the *Rec Channel* window is shown in the lower half section of the display, press the [EXIT] button.) Use the Cursor button [▲] to select *1 Section*, and then use the [3 ▲▼]/[4 ▲▼] (*Section*) buttons to select a Section.

**NOTE** Fill In A – D, Intro 1 – 4 and Ending 1 – 4 can be selected on the display although they are not available on the panel.

As necessary, make the following settings.

- For the current Section, select the pattern length via the [5 ▲▼]/[6 ▲▼] (*Pattern Length*) buttons. After selecting, press the [ENTER] button to actually enter the specified length.
- For the entire current Style, use the Cursor buttons [▲][▼] to select 2 *Tempo/Time Signature*, and then set the Tempo via the [3 ▲▼]/[4 ▲▼] buttons, and the Time Signature via the [5 ▲▼]/[6 ▲▼] buttons.

**NOTE** Changing the Time Signature clears the data from all sections, and you will need to create the Style from scratch.

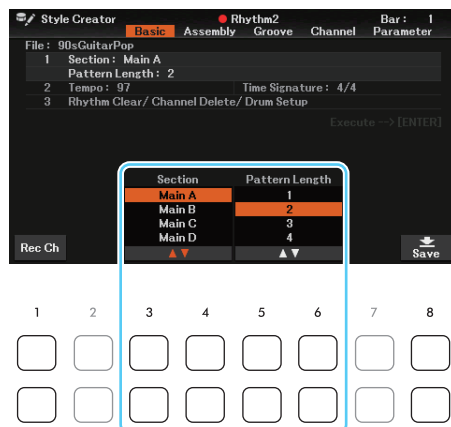

## 5 Create the Source Pattern for each channel.

- **Realtime Recording on the *Basic* page (page 28)**  
Lets you record the Style by simply playing the keyboard.
- **Style Assembly on the *Assembly* page (page 32)**  
Lets you copy various patterns from other preset Styles or Styles you have already created.

## 6 Edit the already recorded channel data.

- **Editing the channel data on the *Groove* (page 34), and *Channel* (page 36) pages**  
Lets you change the rhythmic feel, quantizing and velocity, etc.
- **Editing the SFF parameters on the *Parameter* page (page 37)**  
Lets you edit the SFF (Style File Format) related parameters of the already recorded channels.
- **Editing the rhythm part on the *Basic* page by using the *Drum Setup* function (page 41)**  
Lets you edit the rhythm part of the Style, such as changing the sounds of the individual instruments.

## 7 Repeat steps 4–6 as desired.

## 8 Press one of the [8 ▲▼] (Save) buttons on any of the pages to save the created Style.

For instructions, refer to “Basic Operations” in the Owner’s Manual.

### **NOTICE**

The created Style will be lost if you change to another Style or turn off the power to the instrument without carrying out the Save operation.

# Realtime Recording

In the *Basic* page, you can record your original rhythm pattern from the keyboard.

## Realtime Recording Characteristics in the Style Creator

### • Loop Recording

Style playback repeats the rhythm patterns of several measures in a “loop,” and Style recording is also done using loops. For example, if you start recording with a two-measure Main section, the two measures are repeatedly recorded. Notes that you record will play back from the next repetition (loop), letting you record while hearing previously recorded material.

### • Overdub Recording

This method records new material to a channel already containing recorded data, without deleting the original data. In Style recording, the recorded data is not deleted, except when using functions such as *Rhythm Clear* (page 29) and *Channel Delete* (pages 29, 31). For example, if you start recording with a two-measure Main section, the two measures are repeated many times. Notes that you record will play back from the next repetition, letting you overdub new material to the loop while hearing previously recorded material. When creating a Style based on an existing internal Style, overdub recording is applied only to the rhythm channels. For all other channels (except rhythm), you need to delete the original data before recording.

3

Styles

## ■ Recording Rhythm Channels 1–2

The procedure below applies to step 5 in the Basic Procedure on page 27.

- 1 From the *Basic* page, use the [1 ▲▼] (*Rec Ch*) buttons to call up the *Rec Channel* window in the lower half section of the display.

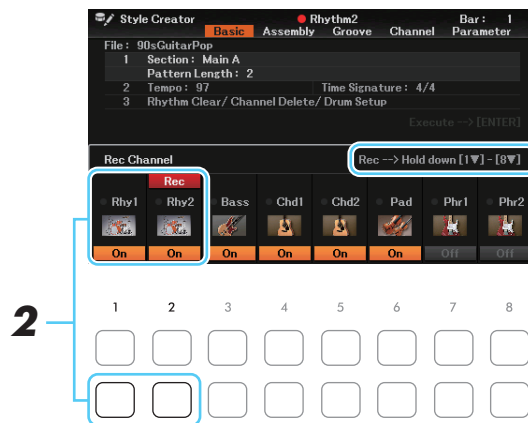

- 2 Hold down the [1 ▼] (*Rhy1*) or [2 ▼] (*Rhy2*) button to select the desired channel as the recording target.

A Rhythm channel can be selected as the recording target no matter whether already recorded data is included or not. If already recorded data is included in the selected channel, you can record notes additionally to the existing data.

- 3 If necessary, select a Voice then practice the rhythm pattern to be recorded.

Press the [1 ▲] or [2 ▲] button (selected channel) to call up the Voice Selection display then select the desired Voice—in this case, a Drum Kit, since we'll be creating a rhythm. After selecting, press the [EXIT] button to return to the original Style Creator display. With the selected Voice, practice the rhythm pattern to be recorded.

### • Available Voices for recording

For the *Rhy1* channel, all Voices can be used for recording.

For the *Rhy2* channel, only Drum/SFX Kits can be used for recording.

**NOTE** For information on which key to play for each Drum/SFX sound, refer to the *Drum/Key Assignment List* in the Data List on the website.

#### 4 Press the STYLE CONTROL [START/STOP] button to start recording.

As the already recorded data plays back, use the [1 ▼]–[8 ▼] buttons to turn each channel on or off as desired.

If necessary, you can delete channel data. Use the Cursor buttons [▲][▼] to select **3 Rhythm Clear/Channel Delete/Drum Setup**, and then press one of the [4 ▲▼]/[5 ▲▼] (**Channel Delete**) buttons to call up the operation display. On the **Channel Delete** window, press the [1 ▲]–[8 ▲] buttons corresponding to the desired channel to delete, and then press the [ENTER] button to actually delete the channel data. To close the **Channel Delete** window, press the [EXIT] button.

#### 5 As soon as loop playback returns to the first beat in the first measure, start playing the rhythm pattern to be recorded.

If the rhythm is difficult to play in real time, break it up into individual parts and play each separately as the playback loops, as shown in the example below.

The diagram illustrates a three-round loop recording process. Each round is shown in a separate box with a downward arrow indicating the sequence.

- Loop 1st round:** Shows a single staff for Bass Drum with a rhythmic pattern of quarter notes.
- Loop 2nd round:** Shows two staves: Snare Drum and Bass Drum. The Snare Drum part has a rhythmic pattern of quarter notes, and the Bass Drum part has a rhythmic pattern of quarter notes.
- Loop 3rd round:** Shows three staves: Hi-Hat, Snare Drum, and Bass Drum. The Hi-Hat part has a rhythmic pattern of quarter notes, the Snare Drum part has a rhythmic pattern of quarter notes, and the Bass Drum part has a rhythmic pattern of quarter notes.

#### Deleting mistakenly recorded notes (Rhythm Clear)

If you make a mistake or play any wrong notes, you can delete those specific notes. Use the Cursor buttons [▲][▼] to select **3 Rhythm Clear/Channel Delete/Drum Setup**. While holding down one of the [2 ▲▼]/[3 ▲▼] (**Rhythm Clear**) buttons, press the corresponding key on the keyboard.

#### 6 Press the [START/STOP] button to stop playback.

If you want to add more notes, press the [START/STOP] button again to continue recording.

#### 7 Press the appropriate [1 ▼] (**Rhy1**) or [2 ▼] (**Rhy2**) button on the **Rec Channel** window to disable recording.

If the **Rec Channel** window is not shown, use the [1 ▲▼] (**Rec Ch**) buttons.

#### **NOTICE**

The created Style will be lost if you change to another Style or turn off the power to the instrument without carrying out the Save operation (step 8 on page 27).

## ■ Recording to the Bass, Chord 1–2, Pad and Phrase 1–2 Channels

The procedure below applies to step 5 in the Basic Procedure on [page 27](#).

- 1 From the *Basic* page, use the [1 ▲▼] (*Rec Ch*) buttons to display the *Rec Channel* window in the lower half section of the display.

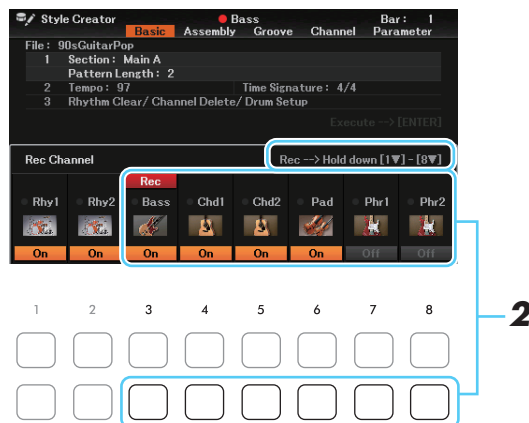

- 2 Hold down one of the [3 ▼]–[8 ▼] (*Bass–Phr2*) buttons to select the desired channel as the recording target.

If a preset Style is selected, a confirmation message appears, prompting you whether or not to delete the already recorded data of the selected channel. Press one of the [7 ▲▼] (*OK*) buttons to delete data and the selected channel is specified as the recording target. Note that channel data other than the Rhythm channels of the preset Style cannot be overdubbed.

- 3 If necessary, select a Voice, and then practice the bass line, chord backing, or phrase to be recorded.

Press one of the [3 ▲]–[8 ▲] buttons (selected channel) to call up the Voice Selection display then select the desired Voice. After selecting, press the [EXIT] button to return to the original display. With the selected Voice, practice the phrase or chord backing to be recorded.

- **Available Voices for recording**  
Any except for the Drum Kit/SFX kit Voices can be used for recording.
- **Record a phrase in CM7 (for playing appropriate notes while chords change during performance)**

### Rules when recording a Main or Fill

With the default initial settings, the *Source Root/Chord* ([page 38](#)) is set to CM7. This means that you should record a Source Pattern using a CM7 scale, which will change according to the chords you specify during normal performance. Record a bass line, phrase or chord backing which you want to hear when CM7 is specified. See below for details.

- Use only the CM7 scale tones when recording the *Bass* and *Phr* (Phrase) channels (i.e., C, D, E, G, A, and B).
- Use only the chord tones when recording the *Chd* (Chord) and *Pad* channels (i.e., C, E, G, and B).



C = Chord note  
C, R = Recommended note

If you observe this rule, Style playback notes are appropriately converted depending on the chord changes you make during your performance.

### Rules when recording an Intro or Ending

These Sections are designed assuming that the chord is not changed during playback. This is why you need not observe the rule for Main and Fill-in Sections described above, and you can create special chord progressions when recording. However, follow the rules below since the *Source Root/Chord* is set to CM7.

- When recording the Intro, make sure that the recorded phrase leads properly into a C scale.
- When recording the Ending, make sure that the recorded phrase begins with or properly follows a C scale.

- **Set the Source Root/Chord if necessary**

Although the *Source Root/Chord* is set to CM7 as described above, you can change this to any desired key or chord. Use the TAB [◀][▶] buttons to call up the *Parameter* page, and set the *Source Root* and *Chord* to the favorite or desired Root and Chord type. Keep in mind that when you change the Source Chord from the default CM7 to another chord, the chord notes and recommended notes will also change. For details, refer to [page 38](#).

#### 4 Press the STYLE CONTROL [START/STOP] button to start recording.

Since already recorded data plays back, use the [1 ▼]–[8 ▼] buttons to turn on or off each channel as desired.

If necessary, you can delete channel data. Use the Cursor buttons [▲][▼] to select *3 Rhythm Clear/Channel Delete/Drum Setup*, and then press one of the [4 ▲▼]/[5 ▲▼] (*Channel Delete*) buttons to call up the operation display. On the *Channel Delete* window, press the [1 ▲]–[8 ▲] buttons corresponding to the desired channel to be deleted, then press the [ENTER] button to actually delete the channel data. To close the *Channel Delete* window, press the [EXIT] button.

#### 5 As soon as loop playback returns to the first beat in the first measure, start playing the bass line, chord backing or phrase to be recorded.

#### 6 Press the [START/STOP] button to stop playback.

If you want to add more notes, press the [START/STOP] button again to continue recording.

- **To hear the playback sound of the already recorded channels with another Source Root/Chord:**

- 1) Use the TAB [◀][▶] buttons to call up the *Parameter* page.
- 2) Use the [1 ▲▼] (*Rec Ch*) buttons to call up the *Rec Channel* window, and then use the [1 ▼]–[8 ▼] buttons to turn the desired channel on/off.
- 3) Press the [EXIT] button to close the *Rec Channel* window.
- 4) Press the STYLE CONTROL [START/STOP] button to start playback.
- 5) On the *Parameter* page, set the *Play Root* and *Chord* to the desired Chord root and Chord type.

The above operation lets you hear how the Source Pattern is played back via chord changes during normal performance.

#### 7 Press the appropriate [3 ▼]–[8 ▼] (*Bass–Phr2*) button on the *Rec Channel* window to disable recording.

If the *Rec Channel* window is not shown, use the [1 ▲▼] (*Rec Ch*) buttons.

#### **NOTICE**

The created Style will be lost if you change to another Style or turn off the power to the instrument without carrying out the Save operation (step 8 on [page 27](#)).

# Assigning the Source Pattern to Each Channel (Assembly)

The instructions below apply to step 5 of the Basic Procedure on [page 27](#). On the *Assembly* page, you can copy channel data as a Source Pattern from another Style to the currently edited Style. Use this function if you find a favorite rhythm pattern, bass line, chord backing or phrase from another Style.

## 1 In the Assembly page, select the Section to be edited if necessary.

Even if the Section to be edited has already been selected on the *Basic* page, you can change the Section also on the *Assembly* page. Press one of the Section buttons on the panel to call up the *Section* window, and then use the [5 ▲▼]/[6 ▲▼] (*Section*) buttons to select the desired section. After selecting, use the [8 ▲▼] (*OK*) buttons to actually enter the selection.

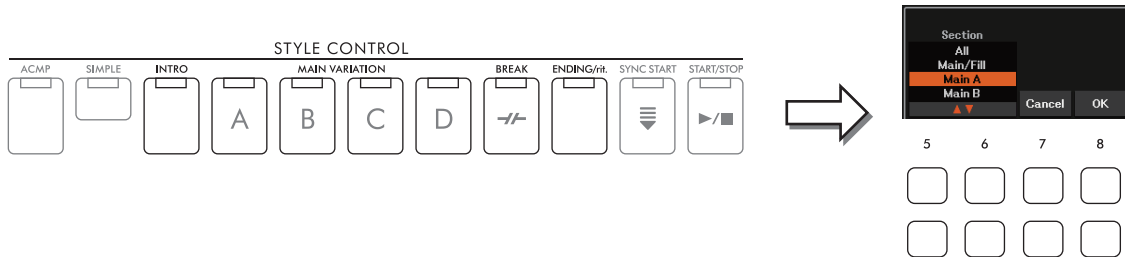

**NOTE** Fill In A – D, Intro 1 – 4 and Ending 1 – 4 can be selected on the display although they are not available on the panel.

## 2 Select the desired channel to be replaced via the Cursor buttons [▲][▼][◀][▶].



## 3 Press the [ENTER] button to call up the Style Selection display.

## 4 Select the desired Style, and then press the [EXIT] button to return to the original display.

## 5 Select the Section and Channel of the selected Style by using the [2 ▲▼]/[3 ▲▼] (*Section*) and [4 ▲▼]/[5 ▲▼] (*Channel*) buttons.

## 6 Confirm the sound with the newly assigned Source Pattern by pressing the STYLE CONTROL [START/STOP] button to playback the Style.



### Setting the Playback Type During Style Assembly

When assembling the Style while listening to Style playback, you can select the playback channels (type). In the *Assembly* page, use the [6 ▲▼]/[7 ▲▼] (*Play Type*) buttons to select the type.

- **Solo**: Plays back the selected channel in the *Assembly* page. Any channels set to **Rec** in the *Rec Channel* window on the *Basic* page are played back simultaneously.
- **On**: Plays back the selected channel in the *Assembly* page. Any channels set to other than **Off** in the *Rec Channel* window on the *Basic* page are played back simultaneously.
- **Off**: Mutes the selected channel in the *Assembly* page.

**7** As desired, repeat steps 2 – 6 for another channel.

#### **NOTICE**

The created Style will be lost if you change to another Style or turn off the power to the instrument without carrying out the Save operation (step 8 on [page 27](#)).

## Editing the Rhythmic Feel (Groove)

The instructions below apply to step 6 of the Basic Procedure on [page 27](#). On the **Groove** page, you can change the timing of all notes and velocities, and edit the rhythmic feel for each channel of the current Section selected on the **Basic** page or the panel button.

- In the **Groove** page, use the Cursor buttons [▲][▼] to select the edit menu, and then edit the data by using the [1 ▲▼]–[7 ▲▼] buttons.

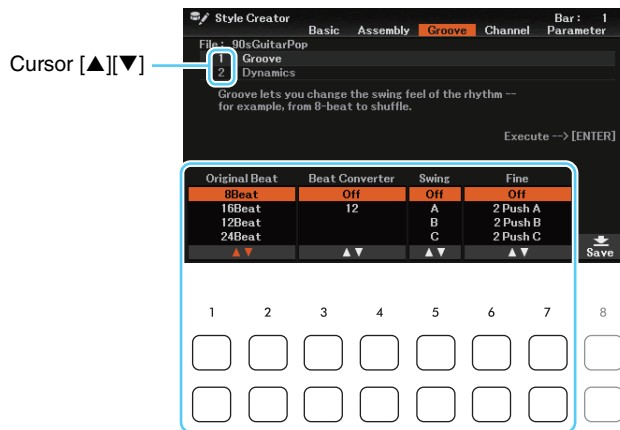

### 1 Groove

This lets you add swing to the music or change the “feel” of the beat by making subtle shifts in the timing (clock) of the Style. The Groove settings are applied to all channels of the Section selected on the **Basic** page.

[1 ▲▼]/ [2 ▲▼]	<b>Original Beat</b>	Specifies the beats to which Groove timing is to be applied. In other words, if <b>8 Beat</b> is selected, Groove timing is applied to 8th notes; if <b>12 Beat</b> is selected, Groove timing is applied to 8th-note triplets.
[3 ▲▼]/ [4 ▲▼]	<b>Beat Converter</b>	Actually changes the timing of the beats (specified in the <b>Original Beat</b> parameter above) to the selected value. For example, when <b>Original Beat</b> is set to <b>8 Beat</b> and <b>Beat Converter</b> is set to “12,” all 8th notes in the section are shifted to 8th-note triplet timing. The “16A” and “16B” Beat Converter which appear when <b>Original Beat</b> is set to <b>12 Beat</b> are variations on a basic 16th-note setting.
[5 ▲▼]	<b>Swing</b>	Produces a “swing” feel by shifting the timing of the back beats, depending on the <b>Original Beat</b> parameter above. For example, if the specified <b>Original Beat</b> value is <b>8 Beat</b> , the Swing parameter will selectively delay the 2nd, 4th, 6th, and 8th beats of each measure to create a swing feel. The settings “A” through “E” produce different degrees of swing, with “A” being the most subtle and “E” being the most pronounced.
[6 ▲▼]/ [7 ▲▼]	<b>Fine</b>	Selects a variety of Groove “templates” to be applied to the selected section. The <b>Push</b> settings cause certain beats to be played early, while <b>Heavy</b> settings delay the timing of certain beats. The numbered settings (2, 3, 4, 5) determine which beats are to be affected. All beats up to the specified beat—but not including the first beat—will be played early or delayed (for example, the 2nd and 3rd beats, if “3” is selected). In all cases, “A” types produce minimum effect, “B” types produce medium effect, and “C” types produce maximum effect.

## 2 Dynamics

This changes the velocity/volume (or accent) of certain notes in the Style playback. The Dynamics settings are applied to each channel or all channels of the Section selected on the **Basic** page.

[2 ▲▼]	<b>Channel</b>	Selects the desired channel (part) to which Dynamics is to be applied. The selected channel is shown at the upper left of the display.
[3 ▲▼]/ [4 ▲▼]	<b>Accent Type</b>	Determines the type of accent applied—in other words, which notes in the part(s) are emphasized with the Dynamics settings.
[5 ▲▼]	<b>Strength</b>	Determines how strongly the selected <b>Accent Type</b> (above) will be applied. The higher the value, the stronger the effect.
[6 ▲▼]	<b>Expand/Comp.</b>	Expands or compresses the range of velocity values. Values higher than 100% expand the dynamic range, while values lower than 100% compress it.
[7 ▲▼]	<b>Boost/Cut</b>	Boosts or cuts all velocity values in the selected section/channel. Values above 100% boost the overall velocity, while values below 100% reduce it.

## 2 Press the [ENTER] button to actually enter the edits for each display.

The values which are shown in the **Strength**, **Expand/Comp.** and **Boost/Cut** parameters are expressed as a percentage of the last set value.

After the operation is completed, “**Undo** -> [ENTER]” is displayed. You can restore the original data if you are not satisfied with the Groove or Dynamics results by pressing the [ENTER] button. The Undo function only has one level; only the previous operation can be undone.

### **NOTICE**

The edited Style will be lost if you change to another Style or turn off the power to the instrument without carrying out the Save operation (step 8 on page 27).

## Editing Data for Each Channel (*Channel*)

The instructions below apply to step 6 of the Basic Procedure on [page 27](#). On the *Channel* page, you can edit recorded data for each channel of the current Section selected on the *Basic* page or via the panel buttons.

### 1 In the *Channel* page, use the Cursor buttons [▲][▼] to select the edit menu.

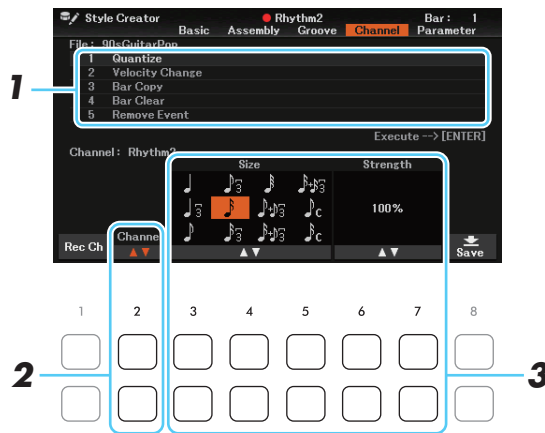

#### 1 *Quantize*

Same as in the Song Creator ([page 56](#)), with the exception of the two additional available parameters below.

 Eighth notes with swing

 Sixteenth notes with swing

#### 2 *Velocity Change*

Boosts or cuts the velocity of all notes in the specified channel, according to the percentage specified here.

#### 3 *Bar Copy*

This function allows data to be copied from one measure or group of measures to another location within the specified channel.

[4 ▲▼]	<i>Top</i>	Specifies the first ( <i>Top</i> ) and last ( <i>Last</i> ) measures in the region to be copied.
[5 ▲▼]	<i>Last</i>	
[6 ▲▼]	<i>Dest.</i>	Specifies the first measure of the destination location, to which the data is to be copied.

#### 4 *Bar Clear*

This function clears all data from the specified range of measures within the selected channel.

#### 5 *Remove Event*

This function lets you remove specific events from the selected channel.

### 2 Use the [2 ▲▼] (*Channel*) buttons to select the channel to be edited.

The selected channel is shown at the upper left of the display.

### 3 Use the [3 ▲▼]–[7 ▲▼] buttons to edit the data.

### 4 Press the [ENTER] button to actually enter the edits for each display.

After the operation is completed, “*Undo* -> [ENTER]” is displayed. You can restore the original data if you are not satisfied with the results of the edit by pressing the [ENTER] button. The Undo function only has one level; only the previous operation can be undone.

#### **NOTICE**

The edited Style will be lost if you change to another Style or turn off the power to the instrument without carrying out the Save operation (step 8 on [page 27](#)).

# Making Style File Format Settings (*Parameter*)

The instructions below apply to step 6 of the Basic Procedure on [page 27](#). The Style File Format (SFF) combines all of Yamaha’s auto accompaniment (Style playback) know-how into a single unified format. Setting the SFF related parameters determines how the original notes are converted to the actual sounded notes based on the chord you specify in the Chord area of the keyboard. The conversion flow is shown below.

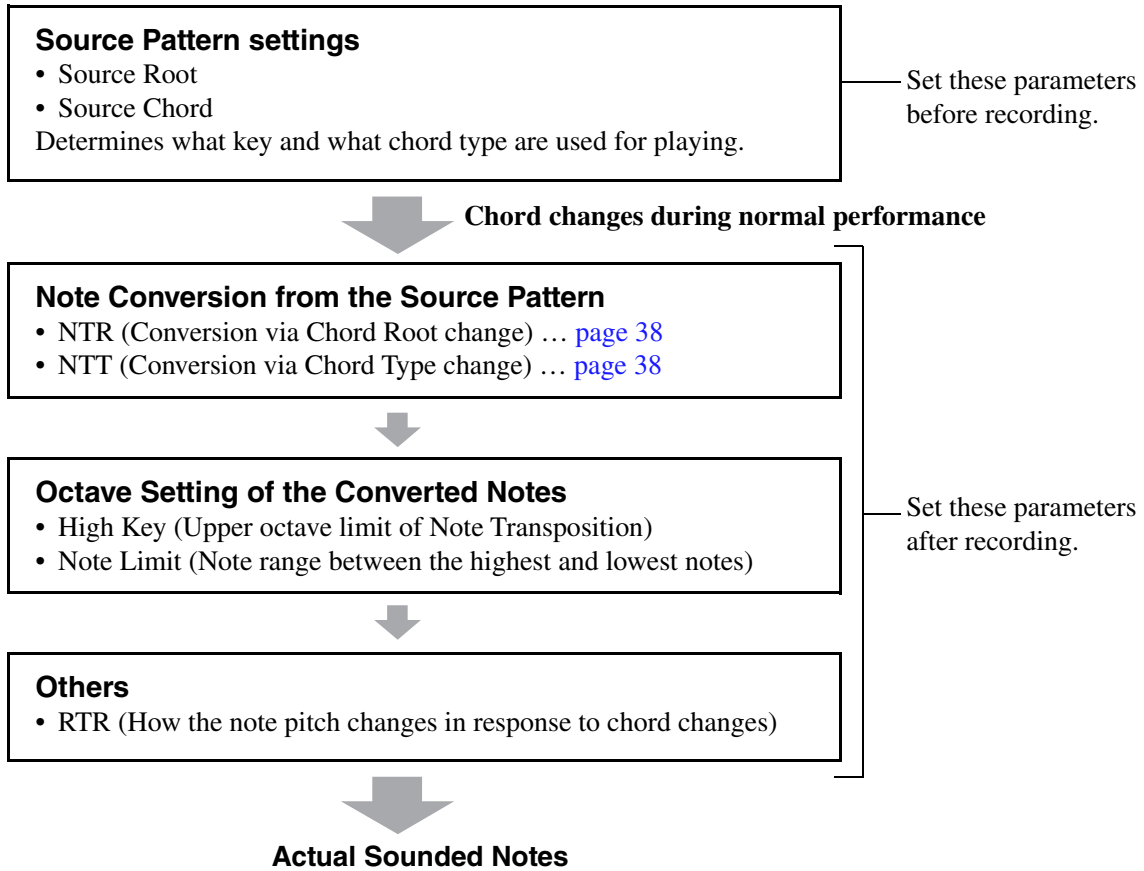

The parameters shown above can be set in the *Parameter* page.

**NOTE** The parameters you can set here are compatible with the SFF GE format. This is why the Style files created on this instrument can be played back only on instruments which are compatible with SFF GE.

## 1 In the *Parameter* page, use the Cursor buttons [▲][▼] to select the edit menu.

For details of the edit menu, see [page 38](#).

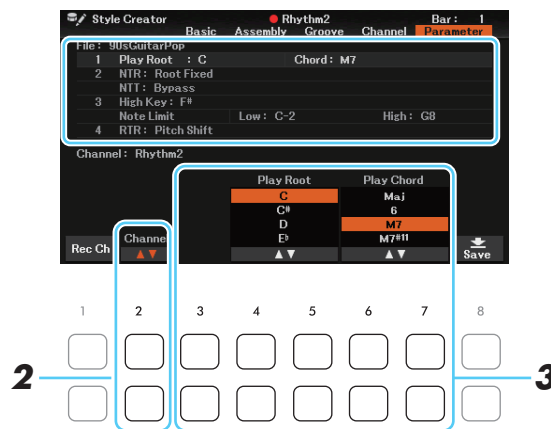

## 2 Use the [2 ▲▼] (*Channel*) buttons to select the channel to be edited.

The selected channel is shown at the upper left of the display.

### 3 Use the [3 ▲▼]–[7 ▲▼] buttons to edit the data.

For details on editable parameters, see below.

#### NOTICE

The edited Style will be lost if you change to another Style or turn off the power to the instrument without carrying out the Save operation (step 8 on page 27).

#### 1 Source Root/Chord (Play Root/Chord)

##### IMPORTANT

The parameters here should be set before recording. If you change the settings after recording, the appropriate note conversion cannot be done even when you specify various chord types.

Before recording, you should set these parameters which determine what key is used for playing when you record the Source Pattern to the Bass, Chord, Pad or Phrase channel. If you set this to “Fm7,” your recorded original phrase (Source Pattern) will be triggered by specifying Fm7 during normal performance. CM7 (Source Chord Root = C and Source Chord Type = M7) is set by default. Depending on the settings here, the playable notes (chord notes and recommended scale notes) will differ. For details, see below.

##### When the Source Root is C:

C = Chord notes  
C, R = Recommended notes

**NOTE** When the parameters for the selected channel are set to *NTR: Fixed*, *NTT: Bypass*, and *Bass: Off*, the parameters here are changed to *Play Root* instead of *Source Root*. In this case, you can hear the resulting sound while you change the Chord Root/Type during playback.

**NOTE** The settings here are not applied when *NTR* is set to *Gtr*.

#### 2 NTR/NTT

The settings here determine how the original notes of the Source Pattern are converted in response to the Chord change during normal performance.

[3 ▲▼]	<b>NTR</b> (Note Transposition Rule)	Determines the relative position of the root note in the chord, when converted from the Source Pattern in response to chord changes. Refer to the list below.
[4 ▲▼]– [6 ▲▼]	<b>NTT</b> (Note Transposition Table)	Sets the note transposition table for the source pattern. Refer to the list below.
[7 ▲▼]	<b>Bass</b>	The channel for which this is set to <b>On</b> will be played back by the bass root note, when the on-bass chord is recognized by the instrument. When <i>NTR</i> is set to <b>Gtr</b> and this parameter is set to <b>On</b> , only the note which is assigned to bass will be played back by the bass root note.

**NOTE** Since the Rhythm channels should not be affected by chord changes, make sure that the parameters are set to *NTR: Fixed*, *NTT: Bypass*, and *Bass: Off*. In this case, *Source Root* is changed to *Play Root*.

## NTR (Note Transposition Rule)

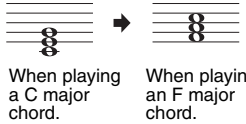
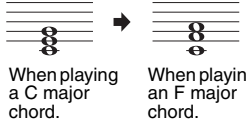
<b>Trans</b> (Root Transpose)	When the root note is transposed, the interval between notes is maintained. For example, the notes C3, E3 and G3 in the key of C become F3, A3 and C4 when they are transposed to F. Use this setting for channels that contain melody lines.	
<b>Fixed</b> (Root Fixed)	The note is kept as close as possible to the previous note range. For example, the notes C3, E3 and G3 in the key of C become C3, F3 and A3 when they are transposed to F. Use this setting for channels that contain chord parts.	
<b>Gtr</b> (Guitar)	This is exclusively for transposing guitar accompaniment. Notes are transposed to approximate the chords played with natural guitar fingering.	

## NTT (Note Transposition Table)

When **NTR** is set to **Trans** or **Fixed**

<b>Bypass</b>	When <b>NTR</b> is set to <b>Fixed</b> , the transposition table used does not do any note conversion. When <b>NTR</b> is set to <b>Trans</b> , the table used only converts the notes by maintaining the pitch relationship between notes.
<b>Melody</b>	Suitable for melody line transposition. Use this for melody channels such as Phrase 1 and Phrase 2.
<b>Chord</b>	Suitable for chordal parts transposition. Use this for the Chord 1 and Chord 2 channels, especially when they contain piano or guitar-like chordal parts.
<b>Melodic Minor</b>	When the played chord changes from a major to a minor chord, this table lowers the third interval in the scale by a semitone. When the chord changes from a minor to a major chord, the minor third interval is raised by a semitone. Other notes are not changed. Use this for melody channels of Sections which respond only to major/minor chords, such as Intros and Endings.
<b>Melodic Minor 5th</b>	In addition to the Melodic Minor transposition above, augmented and diminished chords affect the 5th note of the Source Pattern.
<b>Harmonic Minor</b>	When the played chord changes from a major to a minor chord, this table lowers the third and sixth intervals in the scale by a semitone. When the chord changes from a minor to a major chord, the minor third and flatted sixth intervals are raised by a semitone. Other notes are not changed. Use this for chord channels of Sections which respond only to major/minor chords, such as Intros and Endings.
<b>Harmonic Minor 5th</b>	In addition to the Harmonic Minor transposition above, augmented and diminished chords affect the 5th note of the Source pattern.
<b>Natural Minor</b>	When the played chord changes from a major to a minor chord, this table lowers the third, sixth and seventh intervals in the scale by a semitone. When the chord changes from a minor to a major chord, the minor third, flatted sixth and flatted seventh intervals are raised by a semitone. Other notes are not changed. Use this for chord channels of Sections which respond only to major/minor chords such as in Intros and Endings.
<b>Natural Minor 5th</b>	In addition to the Natural Minor transposition above, augmented and diminished chords affect the 5th note of the Source pattern.
<b>Dorian</b>	When the played chord changes from a major to a minor chord, this table lowers the third and seventh intervals in the scale by a semitone. When the chord changes from a minor to a major chord, the minor third and flatted seventh intervals are raised by a semitone. Other notes are not changed. Use this for chord channels of Sections which respond only to major/minor chords such as in Intros and Endings.
<b>Dorian 5th</b>	In addition to the Dorian transposition above, augmented and diminished chords affect the 5th note of the Source pattern.

When *NTR* is set to *Gtr*

<b>All-Purpose</b>	This table covers both stroke- and arpeggio-played sounds.
<b>Stroke</b>	Suitable for strumming sounds of the guitar. Some notes may sound as if they are muted—this is the normal condition when chords are played on guitar by strumming.
<b>Arpeggio</b>	Suitable for arpeggio-played sound of the guitar, resulting in beautiful four-note arpeggio sounds.

### 3 High Key / Note Limit

The settings here adjust the Octave of the notes converted from the original ones through NTT and NTR.

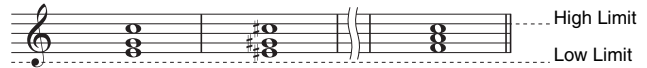
<p>[4 ▲▼]/ [5 ▲▼]</p>	<p><b>High Key</b></p>	<p>This sets the highest key (upper octave limit) of the note transposition for the chord root change. Any notes calculated to be higher than the highest key are transposed down to the next lowest octave. This setting is available only when the <i>NTR</i> parameter (page 38) is set to <b>Root Trans</b>.</p> <p><b>Example—When the highest key is F.</b></p> <p>Root changes → CM      C#M      . . .      FM      F#M      . . .</p> <p>Notes played → C3-E3-G3    C#3-E#3-G#3      F3-A3-C4    F#2-A#2-C#3</p> 
<p>[6 ▲▼]</p>	<p><b>Note Limit Low</b></p>	<p>These set the note range (highest and lowest notes) for Voices recorded to the Style channels. By judicious setting of this range, you can ensure that the Voices sound as realistic as possible—in other words, that no notes outside the natural range are sounded (e.g., high bass sounds or low piccolo sounds).</p>
<p>[7 ▲▼]</p>	<p><b>Note Limit High</b></p>	<p><b>Example—When the lowest note is C3 and the highest is D4.</b></p> <p>Root changes → CM      C#M      . . .      FM      . . .</p> <p>Notes played → E3-G3-C4    E#3-G#3-C#4      F3-A3-C4</p> 

### 4 RTR (Retrigger Rule)

These settings determine whether notes stop sounding or not and how they change pitch in response to chord changes. Use the [4 ▲▼]–[7 ▲▼] (*RTR*) buttons to select one of the following types.

<b>Stop</b>	The notes stop sounding.
<b>Pitch Shift</b>	The pitch of the note will bend without a new attack to match the type of the new chord.
<b>Pitch Shift to Root</b>	The pitch of the note will bend without a new attack to match the root of the new chord. However, the octave of the new note remains the same.
<b>Retrigger</b>	The note is retriggered with a new attack at a new pitch corresponding to the next chord.
<b>Retrigger to Root</b>	The note is retriggered with a new attack at the root note of the next chord. However, the octave of the new note remains the same.



## Editing the Rhythm Part of a Style (Drum Setup)

The procedure below applies to step 6 in the Basic Procedure on [page 27](#). The Drum Setup function allows you to edit the rhythm part of the current Style, such as changing the drum instruments and make various settings.

- 1 From the **Basic** page, use the [1 ▲▼] (*Rec Ch*) buttons to call up the **Rec Channel** window in the lower half section of the display.

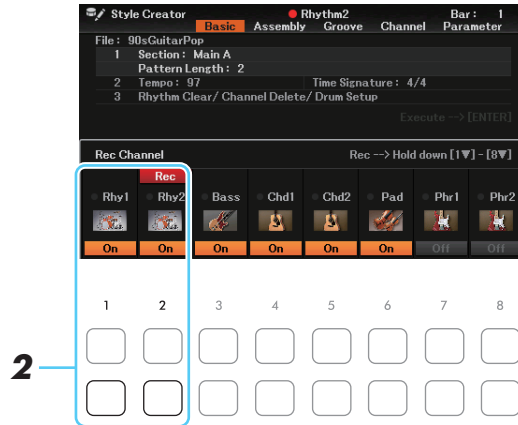

- 2 Hold down the [1 ▼] (*Rhy1*) or [2 ▼] (*Rhy2*) button to select the desired channel as the editing target.

**NOTE** If the different drum sounds are assigned to each section of the selected channel, the sounds are set to that of the current section in order to use the Drum Setup function.

- 3 Use the Cursor buttons [▲][▼] to select 3 *Rhythm Clear/Channel Delete/Drum Setup*, and then press one of the [6 ▲▼]/[7 ▲▼] (*Drum Setup*) buttons to call up the **Drum Setup** window.

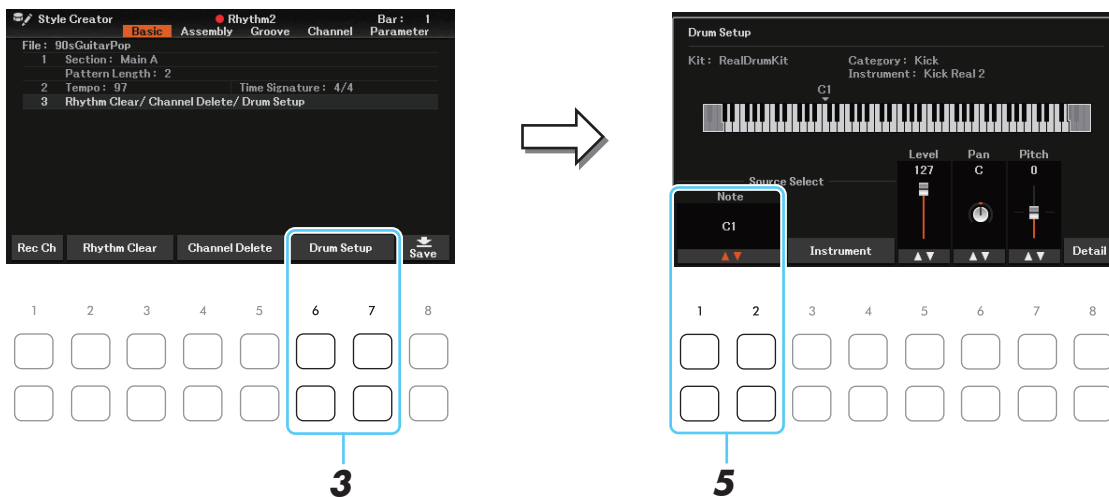

- 4 If necessary, press the **STYLE CONTROL [START/STOP]** button to start playback of the rhythm part.

The sounds played back are indicated on the display keyboard, letting you to check the note to edit.

- 5 Use the [1 ▲▼]/[2 ▲▼] (*Note*) buttons to select the note to edit.

**NOTE** You can also select the note by pressing the note on the keyboard.

## 6 Select the desired instrument to be used.

**6-1** Use the [3 ▲▼]/[4 ▲▼] (*Instrument*) buttons to call up the window to select the instrument.

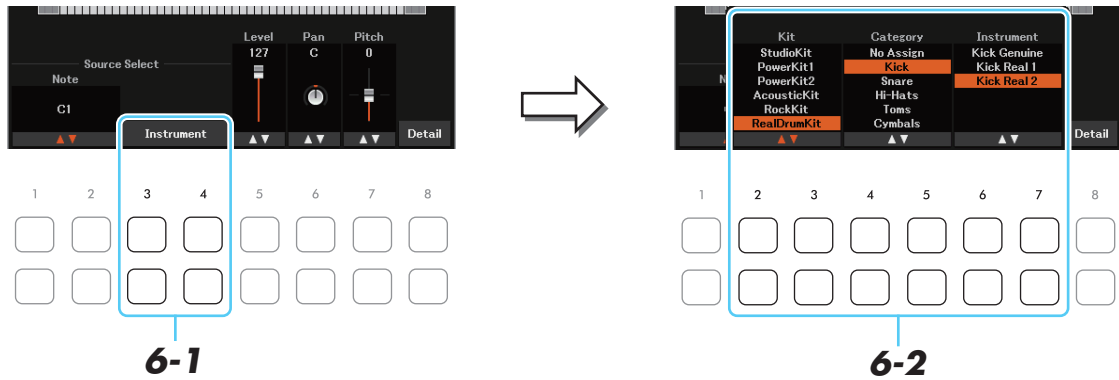

**6-2** Use the [2 ▲▼]–[7 ▲▼] buttons to select the *Kit*, *Category* and *Instrument* in order.

**6-3** Press the [EXIT] button to close the window.

## 7 If necessary, set the volume level, pan or pitch by using the [5 ▲▼]–[7 ▲▼] buttons.

## 8 If necessary, make more detailed settings.

**8-1** Use the [8 ▲▼] (*Detail*) buttons to call up the detailed settings window.

**8-2** Use the [3 ▲▼]–[5 ▲▼] buttons to select the parameter, and then use the [6 ▲▼]/[7 ▲▼] buttons to set the value.

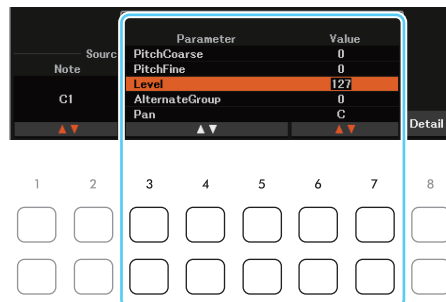

The parameters with “\*” in the list below indicates that the settings here affect the settings in step 7.

<b><i>Pitch Coarse*</i></b>	For coarse tuning of the pitch in semitone increments.
<b><i>Pitch Fine*</i></b>	For fine tuning of the pitch in cent increments. <b>NOTE</b> In musical terms a “cent” is 1/100th of a semitone. (100 cents equal one semitone.)
<b><i>Level*</i></b>	For adjusting the volume level.
<b><i>Alternate Group</i></b>	Determines the Alternate Group. Any instruments in the same group number cannot sound at the same time. Playing any instrument within a numbered group will immediately stop the sound of any other instrument in the same group of the same number. If this is set to 0, the instruments in the group can sound at the same time.
<b><i>Pan*</i></b>	Determines the stereo position.
<b><i>Reverb Send</i></b>	For adjusting the reverb depth.
<b><i>Chorus Send</i></b>	For adjusting the chorus depth

<b>Variation Send</b>	For adjusting the variation effect (DSP1) depth. When the <b>Connection</b> parameter is set to <b>Insertion</b> on the Mixer display and this rhythm channel is selected as the assign part, this parameter affects as below. <ul style="list-style-type: none"> <li>• <b>When Variation Send is set to 0:</b> No effects are applied to the instrument (Insertion Off).</li> <li>• <b>When Variation Send is set to 1–127:</b> Effects are applied to the instrument (Insertion On).</li> </ul>
<b>Key Assign</b>	Determines the Key Assign mode. This parameter is effective only when the kit's XG parameter "SAME NOTE NUMBER KEY ON ASSIGN" (see the Data List on the website) is set to "INST." <ul style="list-style-type: none"> <li>• <b>Single:</b> Each successive playing of the same sound results in the previous being cut off or muted.</li> <li>• <b>Multi:</b> Each sound continues to its full decay, even when played successively multiple times.</li> </ul>
<b>Rcv Note Off</b>	Determines whether note-off messages are received or not.
<b>Rcv Note On</b>	Determines whether note-on messages are received or not.
<b>Filter Cutoff</b>	Determines the cutoff frequency or effective frequency range of the filter. Higher values result in a brighter sound.
<b>Filter Resonance</b>	Determines the emphasis given to the cutoff frequency (resonance), set in Filter Cutoff above. Higher values result in a more pronounced effect.
<b>EG Attack</b>	Determines how quickly the sound reaches its maximum level after the key is played. The higher the value, the quicker the attack.
<b>EG Decay 1</b>	Determines how quickly the sound reaches its sustain level (a slightly lower level than maximum). The higher the value, the quicker the decay.
<b>EG Decay 2</b>	Determines how quickly the sound decays to silence after the key is released. The higher the value, the quicker the decay.

**8-3** Press the [EXIT] button to close the window.

**9** Press the [EXIT] button to close the *Drum Setup* window and return to the *Basic* page.

**NOTICE**

The edited Style will be lost if you change to another Style or turn off the power to the instrument without carrying out the Save operation (step 8 on [page 27](#)).

## Contents

Editing Music Notation (Score) Settings .....	44
Editing Lyrics/Text Display Settings .....	47
Using the Auto Accompaniment Features with Song Playback .....	48
Song Playback Related Parameters (Guide Function, Channel settings, Repeat settings, etc.) .....	49
• Keyboard and Vocal Practice Using the Guide Function .....	50
Creating/Editing Songs (Song Creator) .....	52
• Selecting the Setup Data to be Recorded to the Top Position of the Song (Setup page) .....	52
• Re-recording a Specific Section—Punch In/Out (Rec Mode page) .....	53
• Editing Channel Events of Existing Song Data (Channel page) .....	55

## Editing Music Notation (Score) Settings

After selecting a Song, you can call up the music notation of the current Song by pressing the [SCORE/LYRICS] button. If it is not shown, press the button again. You can change the notation indication as desired to suit your personal preferences.

**NOTE** You can save the settings here as a part of a Song by accessing [MENU] → Cursor buttons [▲][▼][◀][▶] *Song Creator*, [ENTER] → TAB [◀][▶] *Setup*. See [page 52](#).

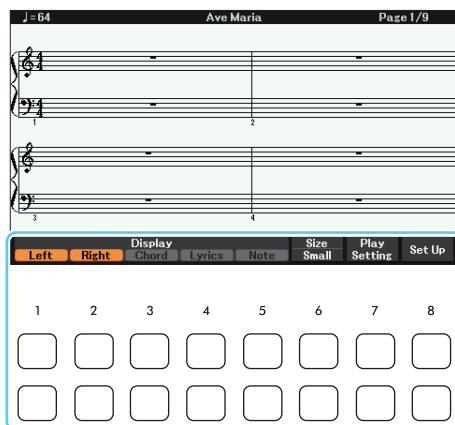

[1 ▲▼]	<b>Left</b>	Turns indication of the left-hand notation on or off. If this parameter appears grayed out and is unavailable, go to the detailed setting display ( <a href="#">page 45</a> ), and then set the <b>Left Ch</b> to any channel except <b>Auto</b> . Or, from the <b>Setting</b> page on the <b>Song Setting</b> display ( <a href="#">page 50</a> ), set the <b>Left</b> parameter of <b>Part Channel</b> to any channel except <b>Off</b> . <b>NOTE</b> Both <b>Right</b> (below) and <b>Left</b> cannot be turned off at the same time.
[2 ▲▼]	<b>Right</b>	Turns indication of the right-hand notation on or off. <b>NOTE</b> Both <b>Right</b> and <b>Left</b> (above) cannot be turned off at the same time.
[3 ▲▼]	<b>Chord</b>	Turns indication of the chords on or off. If the selected Song does not contain chord data, chords are not displayed.
[4 ▲▼]	<b>Lyrics</b>	Turns indication of the Lyrics on or off. If the selected Song does not contain lyric data, lyrics are not displayed. If the Song contains Pedal events, pressing these buttons switches among <b>Pedal</b> , <b>Lyrics</b> and off. When <b>Pedal</b> is selected, Pedal events are shown instead of Lyrics on the display.

[5 ▲▼]	<i>Note</i>	Turns indication of the note names on or off. The note name is indicated at the left of the note. When the space between the notes is too small, the indication may be moved to the top left of the note. If the Song contains Fingering events, pressing these buttons switches among <i>Fingering</i> , <i>Note</i> and off. When <i>Fingering</i> is selected, Fingering events are shown instead of note names on the display.
[6 ▲▼]	<i>Size Small/ Large</i>	Determines the display zoom level of the notation.
[7 ▲▼]	<i>Play Setting</i>	Turns playback on or off for the desired part. <ul style="list-style-type: none"> <li>• <b>Right</b> ([6 ▲▼]): Turns playback on or off for the Right Hand Part, to which you can assign the desired channel by <i>Part Channel</i> on the <i>Setting</i> page of the <i>Song Setting</i> display (page 50).</li> <li>• <b>Left</b> ([5 ▲▼]): Turns playback on or off for the Left Hand Part, to which you can assign the desired channel on the <i>Setting</i> page of the <i>Song Setting</i> display (page 50).</li> <li>• <b>Extra</b> ([4 ▲▼]): Turns playback of all channels on or off, except for those assigned to the Left and Right Hand Parts described above.</li> </ul>
[8 ▲▼]	<i>Set Up</i>	Calls up the detailed setting display. See below.

Pressing the [8 ▲▼] (*Set Up*) button on the Score display calls up the detailed setting display. You can set the view type by using the [1 ▲▼]–[6 ▲▼] buttons, and then press the [8 ▲] (*OK*) button.

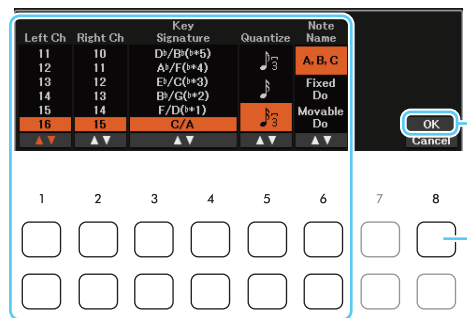

[1 ▲▼]	<i>Left Ch</i>	Determines which MIDI channel in the Song data is used for the left-hand/right-hand part. This setting returns to <i>Auto</i> when a different Song is selected. <ul style="list-style-type: none"> <li>• <b>Auto</b>: The MIDI channels in the Song data for the right- and left-hand parts are assigned automatically—setting each part to the channel which has been specified at the <i>Part Channel</i> on the <i>Setting</i> page of the <i>Song Setting</i> display (page 50).</li> <li>• <b>1–16</b>: Assigns the specified MIDI channel (1–16) to each of the left- and right-hand parts.</li> <li>• <b>Off (Left Ch only)</b>: Assigns no channel to the left-hand part. This disables display of the left-hand key range.</li> </ul>
[2 ▲▼]	<i>Right Ch</i>	
[3 ▲▼]/ [4 ▲▼]	<i>Key Signature</i>	This lets you enter key signature changes in the middle of a Song, at the stopped position. This menu is useful when the selected Song contains no key signature settings for displaying notation.
[5 ▲▼]	<i>Quantize</i>	This gives you control over the note resolution in the notation, letting you shift or correct the timing of all displayed notes so that they line up to a particular note value. Make sure to select the smallest note value used in the Song.

[6 ▲▼]	<i>Note Name</i>	<p>Selects the type of the note name indicated at the left of the note in the notation from among the following three types. The settings here are available when the <i>Note</i> parameter above is set to <i>On</i>.</p> <ul style="list-style-type: none"> <li>• <b>A, B, C</b>: Note names are indicated as letters (C, D, E, F, G, A, B).</li> <li>• <b>Fixed Do</b>: Note names are indicated in solfeggio, with the note of C fixed to Do.</li> <li>• <b>Movable Do</b>: Note names are indicated in solfeggio according to the scale intervals, and as such are relative to the key. The root note is indicated as Do. For example, in the key of G major the root note of “Sol” would be indicated as “Do.”</li> </ul>
--------	------------------	---

## Editing Lyrics/Text Display Settings

To view the lyrics of the selected Song or the text, press the [SCORE/LYRICS] button. If the Score display is shown instead, press the button again. If you wish to view the lyrics, select a Song beforehand. If you wish to view a computer-generated text file on this instrument's display, connect the USB flash drive containing the text file (up to 60 KB; extension ".txt") beforehand. You can change the lyrics indication as desired to suit your personal preferences.

**NOTE** When the lyrics are garbled or unreadable, you may need to change the Lyrics Language setting from the [MENU] → Cursor buttons [▲][▼][◀][▶] *Song Setting*, [ENTER] → TAB [▶] *Setting* → Cursor button [▼] 2 *Lyrics Language* (page 50).

**NOTE** When you create a text file on a computer, make sure to enter line breaks manually. This is necessary because the auto line breaks cannot be entered on this instrument. If a sentence extends beyond the display and cannot be shown properly, revise the text data by manually entering appropriate line breaks.

### Lyrics display

The lyrics in the Song data are shown.

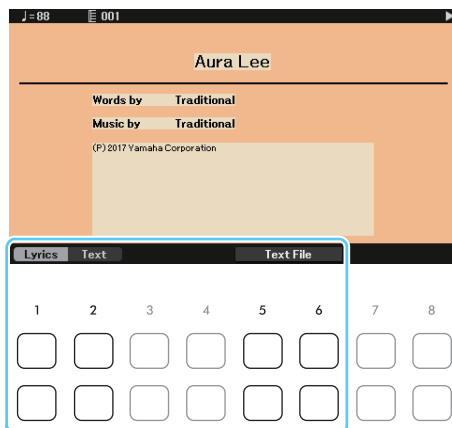

### Text display

The texts created on a computer are shown.

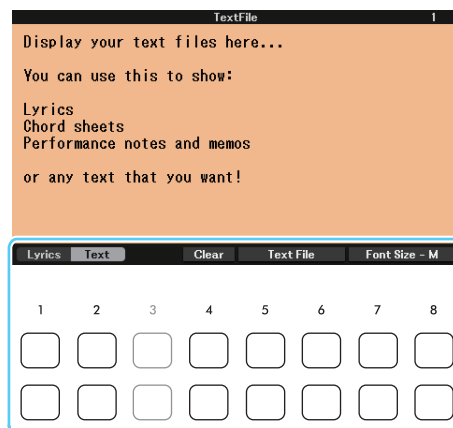

[1 ▲▼]	<b>Lyrics</b>	Switches the screen between the Lyrics display (lyrics data in the Song is shown) and the Text display (a text file selected via the [5 ▲▼]/[6 ▲▼] buttons).
[2 ▲▼]	<b>Text</b>	
[4 ▲▼]	<b>Clear</b> (only when a text file is selected)	Clears the text from the display. This operation does not delete the text file itself, but simply leaves the display empty of any text file.
[5 ▲▼]/ [6 ▲▼]	<b>Text File</b>	Calls up the text File Selection display. After selecting, press the [EXIT] button to return back to the Lyrics/Text display.
[7 ▲▼]/ [8 ▲▼]	<b>Font Size-S/M/L/ S(P)/M(P)/L(P)</b> (only when a text file is selected)	Determines the font type and size. For fonts not indicated with a "P," the letters are uniformly spaced in the same width, and are suitable for displaying lyrics with chord names, since the positions of chord names are fixed to the corresponding lyrics. For fonts indicated with a "P," the letters and spacings have different widths, and are suitable for displaying lyrics without chord names or explanatory notes.

## Using the Auto Accompaniment Features with Song Playback

When playing back a Song and a Style at the same time, channels 9-16 in the Song data are replaced with Style channels—allowing you to play the accompaniment parts of the Song yourself. Try playing chords along with the Song playback as shown in the instructions below.

- 1** Select a Song.
- 2** Select a Style.
- 3** Press the SONG [▶/■] (Play/Pause) button and the [◀◀] (Rewind) button simultaneously.

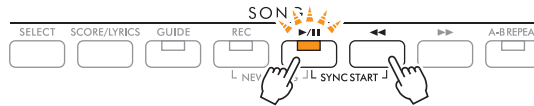

- 4** Make sure that the STYLE CONTROL [ACMP] button is on (the lamp is lit), and then press the [SYNC START] button to enable synchronized start of the accompaniment.

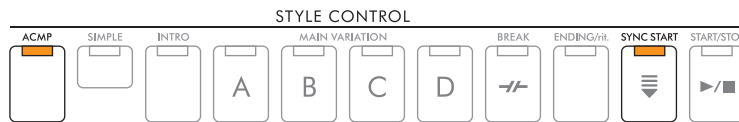

- 5** Press the STYLE CONTROL [START/STOP] button or play the keyboard.

Both the Song and Style start playing together. You can see the chord information on the score display (page 44) while you play.

**NOTE** When playing back a Song and a Style at the same time, the tempo value set in the Song is automatically used.

When the Song playback is stopped, Style playback is also stopped at the same time.



# Song Playback Related Parameters (Guide Function, Channel settings, Repeat settings, etc.)

The instrument has a variety of Song playback functions—repeat playback, various guide settings, etc.—which can be accessed in the display below.

## 1 Call up the operation display.

[MENU] → Cursor buttons [▲][▼][◀][▶] *Song Setting*, [ENTER] → TAB [◀][▶] *Play* or *Setting*

## 2 Use the Cursor buttons [▲][▼] to select the page, and then use the [1 ▲▼]–[8 ▲▼] buttons to make necessary settings.

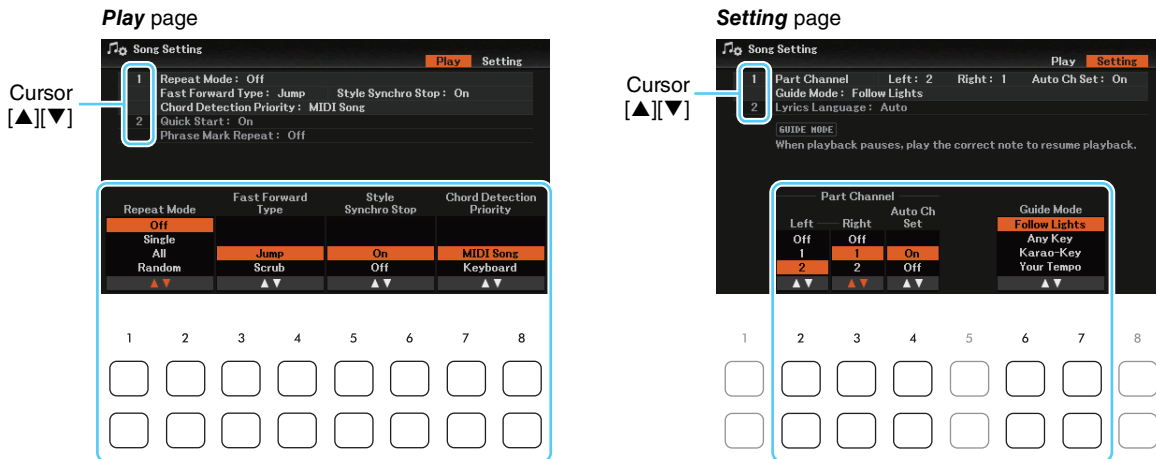

### ■ Play page

#### 1 Repeat Mode, Fast Forward Type, Style Synchro Stop, Chord Detection Priority

[1 ▲▼]/ [2 ▲▼]	<b>Repeat Mode</b>	Determines the method of repeat playback. <ul style="list-style-type: none"> <li>• <b>Off</b>: Plays through the selected Song, then stops.</li> <li>• <b>Single</b>: Plays through the selected Song repeatedly.</li> <li>• <b>All</b>: Continues playback through all the Songs in the specified folder repeatedly.</li> <li>• <b>Random</b>: Continues playback at random through all the Songs in the specified folder repeatedly.</li> </ul>
[3 ▲▼]/ [4 ▲▼]	<b>Fast Forward Type</b>	Determines the fast forward type of when pressing the [▶▶] (Fast Forward) button during Song playback. <ul style="list-style-type: none"> <li>• <b>Jump</b>: Pressing the [▶▶] (Fast Forward) button once instantly sets the playback position to the next measure without sounding. Holding the [▶▶] (Fast Forward) button scrolls forward continuously.</li> <li>• <b>Scrub</b>: Pressing and holding the [▶▶] (Fast Forward) plays and sounds the Song at high speed.</li> </ul>
[5 ▲▼]/ [6 ▲▼]	<b>Style Synchro Stop</b>	When this is set to <b>On</b> , Style playback stops at the same time as when Song playback is stopped. On some Song data which contains settings related to the Style (such as Style start/stop, Style selection, section etc.), Style playback stops when the Song stops regardless of the setting here.

[7 ▲▼]/ [8 ▲▼]	<b>Chord Detection Priority</b>	Determines the priority of the chords for accompaniment, either the ones contained in the Song being played back or the chord you've just played in the chord section of the keyboard. <ul style="list-style-type: none"> <li>• <b>MIDI Song:</b> Gives priority to the chords contained in the Song.</li> <li>• <b>Keyboard:</b> Gives priority to the chords you play in the chord section of the keyboard. Set this if you want to practice playing chords with Song playback. Once you play in the chord section during Song playback, the instrument ignores the chords contained in the Song until the playback ends.</li> </ul>
-------------------	-------------------------------------	--

## 2 Quick Start, Phrase Mark Repeat

[3 ▲▼]/ [4 ▲▼]	<b>Quick Start</b>	On some commercially available Song data, certain settings related to the Song (such as Voice selection, volume, etc.) are recorded to the first measure, before the actual note data. When <b>Quick Start</b> is set to <b>On</b> , the instrument reads all initial non-note data of the Song at the highest possible speed, then automatically slows down to the appropriate tempo at the first note. This allows you to start playback as quickly as possible, with a minimum pause for reading of data.
[5 ▲▼]/ [6 ▲▼]	<b>Phrase Mark Repeat</b>	Phrase Mark is a pre-programmed part of some Song data, which specifies a certain location (set of measures) in the Song. When this is <b>On</b> , the section corresponding to the specified Phrase Mark number is repeatedly played back. This parameter is available only when the Song containing Phrase Mark settings is selected.

### ■ Setting page

#### 1 Part Channel, Guide Mode

[2 ▲▼]	<b>Part Channel</b>	<ul style="list-style-type: none"> <li>• <b>Left, Right:</b> These parameters determine which MIDI channel in the Song data is assigned to the left- or right-hand part of the Guide function and the Song Score function. For the channel specified here, "L" or "R" is shown in the <b>Channel On/Off (Song)</b> display.</li> </ul>
[3 ▲▼]		
[4 ▲▼]		
[6 ▲▼]/ [7 ▲▼]	<b>Guide Mode</b>	See the Guide Function explained below.

#### 2 Lyrics Language

[4 ▲▼]/ [5 ▲▼]	<b>Lyrics Language</b>	Determines the language displayed in the Lyrics display. <ul style="list-style-type: none"> <li>• <b>Auto:</b> When the language is specified in the Song data, the lyrics are displayed accordingly.</li> <li>• <b>International:</b> Handles the displayed lyrics as a western language.</li> <li>• <b>Japanese:</b> Handles the displayed lyrics as Japanese.</li> </ul>
-------------------	------------------------	---

## Keyboard and Vocal Practice Using the Guide Function

With the Guide function, the instrument indicates the timing you need to play notes in the Score display for ease in learning. This instrument also features convenient vocal practice tools that let you adjust the timing of Song playback to match your vocal performance.

### 1 Select the desired Song, and then call up the Score display.



NEXT PAGE

## 2 Call up the setting display.

[MENU] → Cursor buttons [▲][▼][◀][▶] *Song Setting*, [ENTER] → TAB [▶] *Setting* → Cursor button [▲] *1 Guide Mode*.

## 3 Use the [6 ▲▼]/[7 ▲▼] (*Guide Mode*) buttons to select the desired *Guide mode*.

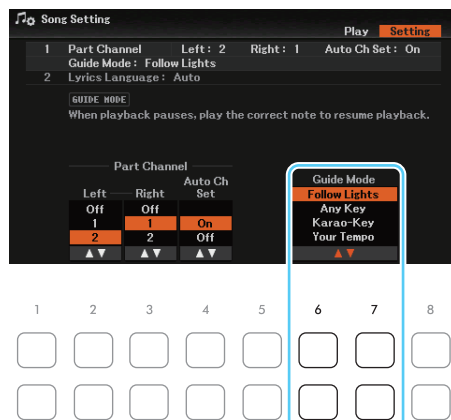

### Guide modes for keyboard practice

#### • *Follow Lights*

When this is selected, Song playback pauses, waiting for you to play the notes correctly. When you play the correct notes, Song playback continues. Follow Lights was developed for the Yamaha Clavinova series. This function is used for practicing purposes, with built-in lamps on the keyboard indicating the notes to be played. Even though the DGX-670 does not have these lamps, you can use the same function by following the indications in the Score display.

#### • *Any Key*

With this function, you can play the melody of a Song just by pressing a single key (any key is OK) in time with the rhythm. Song playback pauses and waits for you to play any key. Simply play a key on the keyboard in time with the music and Song playback continues.

#### • *Your Tempo*

The same as Follow Lights, except that Song playback matches the speed at which you play.

### Guide mode for singing

#### • *Karao-Key*

This function lets you control the Song playback timing with just one finger, while you sing along. This is useful for singing to your own performance. Song playback pauses, waiting for you to sing. Simply play any key on the keyboard (playing the keyboard produces no sound) and Song playback continues.

## 4 Press the SONG [GUIDE] button to turn it on.

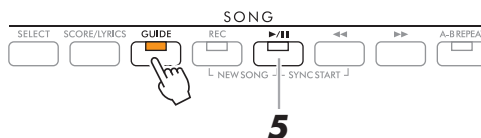

## 5 Press the SONG [▶/||] (Play/Pause) button to start playback.

Practice playing the keyboard or singing, along with the Guide mode selected in step 3.

## 6 After your practice, turn the [GUIDE] button off.

**NOTE** You can save the Guide settings as a part of the Song data (page 52). For Songs to which the Guide settings have been saved, the Guide function will be automatically turned on and the related settings will be recalled when the Song is selected.

# Creating/Editing Songs (Song Creator)

The Owner's Manual covers how to create an original Song by recording your keyboard performance (called "Realtime Recording"). This Reference Manual shows how to edit a recorded Song.

## Selecting the Setup Data to be Recorded to the Top Position of the Song (Setup page)

The current settings of the *Mixer* display and other panel settings you made can be recorded to the top position of the Song as Setup data. The panel settings recorded here are automatically recalled when the Song starts.

- 1** Select the Song to which you want to record the Setup data.
- 2** Call up the operation display.  
[MENU] → Cursor buttons [▲][▼][◀][▶] *Song Creator*, [ENTER] → TAB [◀][▶] *Setup*
- 3** Press the SONG [◀◀] (Rewind) button to move the Song position to the top of the Song.
- 4** Use the Cursor buttons [▲][▼][◀][▶] to select the data to be recorded, and then press the [ENTER] button to enter (or remove) the corresponding checkmark.

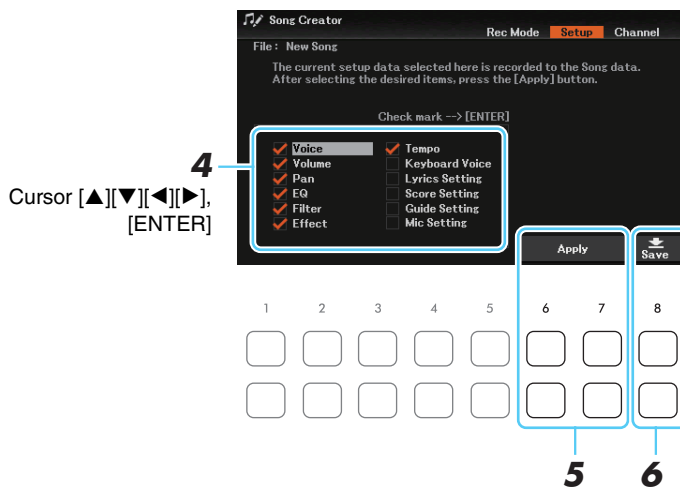

The selected data will be automatically called up when you select the Song, and playback features and functions are recalled. The data selected here can be recorded only to the top position of the Song, except for the *Keyboard Voice*.

- **Voice, Volume, Pan, EQ, Filter, Effect, Tempo:** Records the tempo setting and all settings made from the *Mixer* display (page 66).
- **Keyboard Voice:** Records the panel settings, including the Voice selection of the keyboard parts (Main, Layer and Left) and their on/off status. Panel settings recorded here are same as the ones memorized to the One Touch Setting. This can be recorded at any point in a Song, letting you change Voices in the middle of a Song.
- **Lyrics Setting:** Records the settings in the Lyrics display.
- **Score Setting:** Records the settings in the Score display.
- **Guide Setting:** Records the settings of the Guide functions including the Guide on/off setting.
- **Mic Setting:** Records the microphone settings in the *Mixer* page of the *Mic Setting* display (page 60).

- 5** Use the [6 ▲▼]/[7 ▲▼] (*Apply*) buttons to actually record the data.

## 6 Use the [8 ▲▼] (Save) buttons to carry out the Save operation.

For details, refer to “Basic Operations” in the Owner’s Manual.

### NOTICE

The edited Song data will be lost if you select another Song or turn off the power to the instrument without carrying out the Save operation.

## Re-recording a Specific Section—Punch In/Out (Rec Mode page)

When re-recording a specific section of an already-recorded Song, use the Punch In/Out function. In this method, only the data between the Punch In point and the Punch Out point is overwritten with the newly recorded data. Keep in mind that the notes before and after the Punch In/Out points are not recorded over, although you will hear them play back normally to guide you in the Punch In/Out timing.

### 1 Select the desired Song for re-recording.

### 2 Call up the operation display.

[MENU] → Cursor buttons [▲][▼][◀][▶] *Song Creator*, [ENTER] → TAB [◀] *Rec Mode*

### 3 Determine the settings for recording.

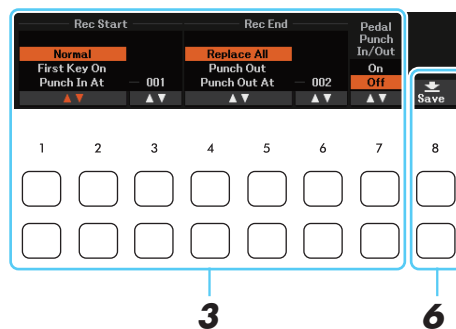

<p>[1 ▲▼]– [3 ▲▼]</p>	<p><b>Rec Start</b> (Punch In)</p>	<p>Determines the recording start behavior by using the [1 ▲▼]/[2 ▲▼] buttons.</p> <ul style="list-style-type: none"> <li>• <b>Normal:</b> Overwrite recording starts when the Song playback is started via the SONG [▶/■] (Play/Pause) button or when you play the keyboard in the Synchro Standby mode.</li> <li>• <b>First Key On:</b> The Song plays back normally, then starts overwrite recording as soon as you play the keyboard.</li> <li>• <b>Punch In At:</b> The Song plays back normally up to the beginning of the indicated Punch In measure, then starts overwrite recording at that point. You can set the Punch In measure by using the [3 ▲▼] buttons.</li> </ul>
<p>[4 ▲▼]– [6 ▲▼]</p>	<p><b>Rec End</b> (Punch Out)</p>	<p>Determines the recording end behavior, or how data is handled after recording is stopped by using the [4 ▲▼]/[5 ▲▼] buttons.</p> <ul style="list-style-type: none"> <li>• <b>Replace All:</b> This deletes all data after the point at which recording is stopped.</li> <li>• <b>Punch Out:</b> The Song position at which recording is stopped is regarded as the Punch Out point. This setting maintains all data after the point at which recording is stopped.</li> <li>• <b>Punch Out At:</b> Actual overwrite recording continues until the beginning of the specified Punch Out measure (set with the corresponding display button), at which point recording stops and normal playback continues. This setting maintains all data after the point at which recording is stopped. You can set the Punch Out measure by using the [6 ▲▼] buttons.</li> </ul>

[7 ▲▼]	<b>Pedal Punch In/Out</b>	<p>When this is set to <b>On</b>, you can use the center pedal of the pedal unit (sold separately) to control the Punch In and Punch Out points. While a Song is playing back, pressing (and holding) the center pedal instantly enables Punch In recording, while releasing the pedal stops recording (Punch Out). You can press and release the center pedal as often as you want during playback to punch in/out of overwrite recording. Note that the current function assignment of the center pedal is canceled when the <b>Pedal Punch In/Out</b> function is set to <b>On</b>.</p> <p><b>NOTE</b> Pedal Punch In/Out operation may be reversed depending on the particular pedal you've connected to the instrument. If necessary, change the pedal polarity to reverse the control (page 76).</p>
--------	---------------------------	--

#### 4 Press the SONG [REC] button.

The **Channel On/Off (Song)** display appears. While holding down the [REC] button, press the appropriate [1 ▲▼]–[8 ▲▼] buttons to set the desired channel to “**Rec.**”

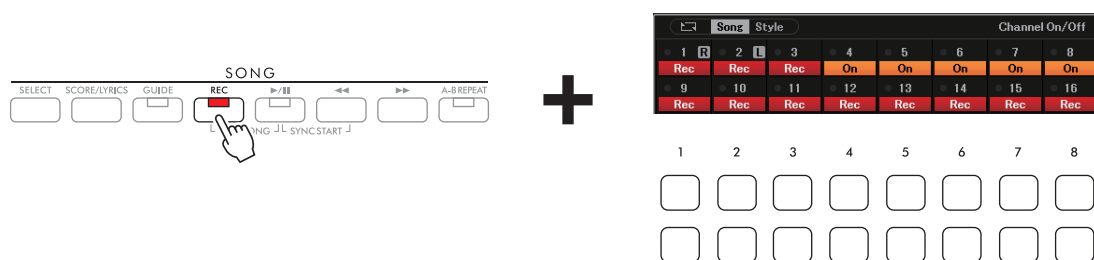

If necessary, use the Data dial to change the part assignment for the channel to be recorded.

#### 5 Press the SONG [▶/||] (Play/Pause) button to start Punch In/Out recording.

According to the settings in step 3, play the keyboard between the Punch In and Punch Out points. Refer to the examples of various settings illustrated on the next page.

#### 6 Use the [8 ▲▼] (Save) buttons to carry out the Save operation.

For details, refer to “Basic Operations” in the Owner’s Manual.

**NOTICE**

The recorded Song data will be lost if you select another Song or turn off the power to the instrument without carrying out the Save operation.

## ■ Examples of re-recording with various Punch In/Out settings

This instrument features several different ways you use the Punch In/Out function. The illustrations below indicate a variety of situations in which selected measures in an eight-measure phrase are re-recorded.

Rec Start setting Rec Stop setting	Original data	
	1 2 3 4 5 6 7 8	
Normal Replace All	Start overwrite recording *1 1 2 3 4 5 Deleted	Stop recording *2
Normal Punch Out	Start overwrite recording *1 1 2 3 4 5 6 7 8	Stop recording *2
Normal Punch Out At 006	Start overwrite recording *1 1 2 3 4 5 6 7 8	Stop overwrite recording/play original data
First Key On Replace All	Play back original data 1 2 3 4 5 Deleted	Play the keyboard to start overwrite recording Stop recording *2
First Key On Punch Out	Play back original data 1 2 3 4 5 6 7 8	Play the keyboard to start overwrite recording Stop recording *2
First Key On Punch Out At 006	Play back original data 1 2 3 4 5 6 7 8	Play the keyboard to start overwrite recording Stop overwrite recording/play original data
Punch In At 003 Replace All	Play back original data 1 2 3 4 5 Deleted	Start overwrite recording Stop recording *2
Punch In At 003 Punch Out	Play back original data 1 2 3 4 5 6 7 8	Start overwrite recording Stop recording *2
Punch In At 003 Punch Out At 006	Play back original data 1 2 3 4 5 6 7 8	Start overwrite recording Stop overwrite recording/play original data

\*1 If you want to re-record from the 3rd measure in this setting, move the Song position to the 3rd measure then start recording to avoid overwriting measures 1–2.

\*2 To stop recording, press the [REC] button at the end of measure 5.

Legend:  
 Previously recorded data  
 Newly recorded data  
 Deleted data

## Editing Channel Events of Existing Song Data (Channel page)

You can apply various useful functions to already recorded data, such as Quantize and Transpose, on the *Channel* page.

- 1** Select a Song to be edited.
- 2** Call up the operation display.  
[MENU] → Cursor buttons [▲][▼][◀][▶] *Song Creator*, [ENTER] → TAB [▶] *Channel*
- 3** Use the Cursor buttons [▲][▼][◀][▶] to select the item to be edited, and then press the [ENTER] button to call up the edit display.

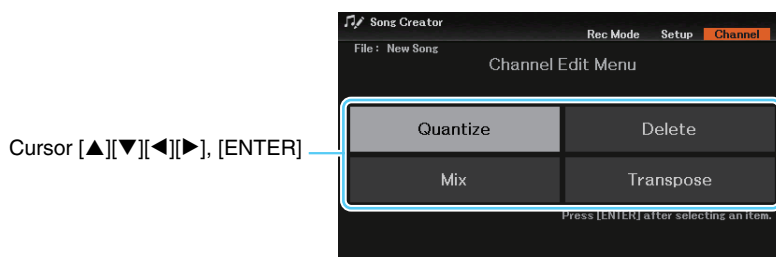

#### 4 Edit the data by referring to the description of each edit display below.

#### 5 Press the [ENTER] button to actually enter the edits for each display.

After the operation is completed, the “*Execute* --> [ENTER]” indication on the display changes to “*Undo* --> [ENTER],” letting you restore the original data if you are not satisfied with the operation results. The Undo function only has one level; only the previous operation can be undone.

#### 6 Use the [8 ▲▼] (Save) buttons to carry out the Save operation.

For details, refer to “Basic Operations” in the Owner’s Manual.









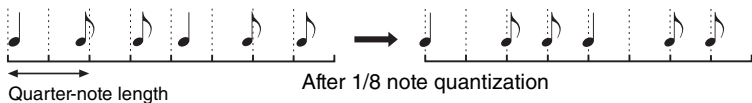

##### **NOTICE**

The edited Song data will be lost if you select another Song or turn off the power to the instrument without carrying out the Save operation.

#### ■ *Quantize*

The Quantize function allows you to align the timing of all the notes in a channel. For example, if you record the musical phrase shown below, you may not play it with absolute precision, and your performance may have been slightly ahead of or behind the precise timing. Quantize is a convenient way of correcting for this.



[1 ▲▼]/ [2 ▲▼]	<b>Channel</b>	Determines which MIDI channel in the Song data is to be quantized.
[3 ▲▼]– [5 ▲▼]	<b>Size</b>	<p>Selects the quantize size (resolution). For optimum results, you should set the Quantize size to the shortest note value in the channel. For example, if eighth notes are the shortest in the channel, you should use eighth note as the Quantize size.</p>  <p>Settings:</p> <div style="display: flex; justify-content: space-around; align-items: flex-start;"> <div style="text-align: center;">  1/4 note         </div> <div style="text-align: center;">  1/8 note         </div> <div style="text-align: center;">  1/16 note         </div> <div style="text-align: center;">  1/32 note         </div> <div style="text-align: center;">  1/16 note+ 1/8 note triplet*         </div> </div> <div style="display: flex; justify-content: space-around; align-items: flex-start; margin-top: 5px;"> <div style="text-align: center;">  1/4 note triplet         </div> <div style="text-align: center;">  1/8 note triplet         </div> <div style="text-align: center;">  1/16 note triplet         </div> <div style="text-align: center;">  1/8 note+ 1/8 note triplet*         </div> <div style="text-align: center;">  1/16 note+ 1/16 note triplet*         </div> </div> <p>The three Quantize settings marked with asterisks (*) are exceptionally convenient, since they allow you to quantize two different note values at the same time. For example, when the straight eighth notes and eighth-note triplets are contained in the same channel, if you quantize by the straight eighth notes, all notes in the channel are quantized to straight eighth notes—completely eliminating any triplet feel. However, if you use the eighth note + eighth note triplet setting, both the straight and triplet notes will be quantized correctly.</p>

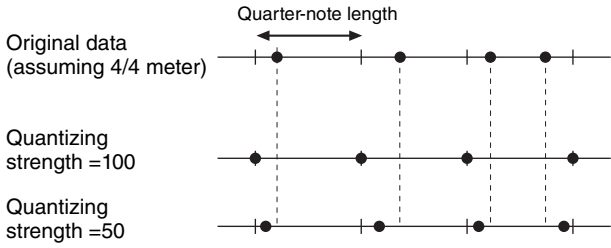

[6 ▲▼]/ [7 ▲▼]	<b>Strength</b>	<p>Determines how strongly the notes will be quantized. A setting of 100% produces exact timing. If a value less than 100% is selected, notes will be moved toward the specified quantization beats according to the specified percentage. Applying less than 100% quantization lets you preserve some of the “human” feel in the recording.</p> 
-------------------	-----------------	---

### ■ Delete

You can delete the data of the specified channel in the Song. Select the channel whose data is to be deleted by using the Cursor buttons [▲][▼][◀][▶], and then enter (or remove) checkmarks by using the [6 ▲▼]/[7 ▲▼] (*Mark*) buttons. Press the [ENTER] button to actually delete the channel(s).

**NOTE** You can enter or remove the checkmarks for all channels by using the [1 ▲▼]/[2 ▲▼] (*All Channels*) buttons.

### ■ Mix

This function lets you mix the data of two channels and place the results in a different channel. It also lets you copy the data from one channel to another.

[2 ▲▼]/ [3 ▲▼]	<b>Source 1</b>	Determines the MIDI channel (1–16) to be mixed. All MIDI events of the channel specified here are copied to the destination channel.
[4 ▲▼]/ [5 ▲▼]	<b>Source 2</b>	Determines the MIDI channel (1–16) to be mixed. Only note events of the channel specified here are copied to the destination channel. Besides the values 1–16, there is a <b>Copy</b> setting that allows you to copy the data from Source 1 to the destination channel.
[6 ▲▼]/ [7 ▲▼]	<b>Destination</b>	Determines the channel into which the mix or copy results will be placed.

### ■ Transpose

This allows you to transpose the recorded data of individual channels up or down by a maximum of two octaves in semitone increments. Select the desired channel to be transposed by using the Cursor buttons [▲][▼][◀][▶], and then set the value by using the data dial. Press the [ENTER] button to actually transpose the channel(s).

**NOTE** You can select all channels by using the [1 ▲▼]/[2 ▲▼] (*All Channels*) buttons, letting you transpose all channels at the same time.

**NOTE** Make sure not to transpose channels 9 and 10. In general, Drum Kits are assigned to these channels. If you transpose the channels of Drum Kits, the instruments assigned to each key will be changed.

This function is fully explained in the Owner's Manual. Refer to the corresponding chapter in the Owner's Manual.

## Microphone

### Contents

Making and Saving the Microphone Settings .....	58
• Parameters that can be set in the Setting page .....	59
Applying Desired Effects to the Microphone Sound .....	60

### Making and Saving the Microphone Settings

This section lets you set parameters for various Effects that are applied to the microphone sound. You should make both *Vocal* and *Talk* settings—*Vocal*, for your singing performance, and *Talk*, for making announcements between songs, for example.

- 1 Call up the operation display.  
[MIC SETTING] → TAB [▶] Setting
- 2 Press the [1 ▲] (*Vocal*) or [1 ▼] (*Talk*) button to select the desired setting display.

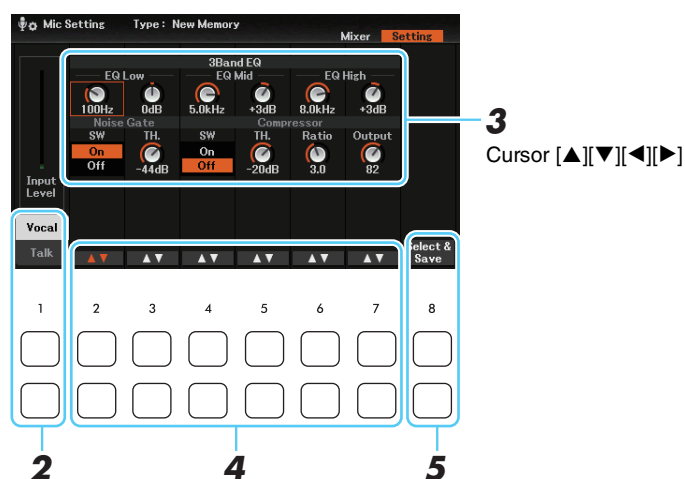

- 3 Use the Cursor buttons [▲][▼][◀][▶] to select the desired parameter to be adjusted.  
For details on each parameter, refer to [page 59](#).

- 4** Set the value for the selected parameter by using the Data dial or the [2 ▲▼] – [7 ▲▼] buttons just below the selected parameter.
- 5** After you have made desired settings, use the [8 ▲▼] (Select & Save) buttons to save the settings as a file to the User drive.

All the settings (both *Vocal* and *Talk*) are saved together as a single file. Up to 60 files can be saved.

**NOTE** The microphone setting file can be saved only to the internal User drive. If you want to save this setting to the USB flash drive, save the User Effect file on the display called up via [MENU] → Cursor buttons [▲][▼][◀][▶] *System*, [ENTER] → TAB [◀][▶] *Setup Files*. For details, refer to [page 90](#).

### Calling Up the Microphone Settings Saved to User drive

- 1** Call up the operation display by using the [8 ▲▼] (Select & Save) buttons as in step 5 above.
- 2** Select the desired setting file.

## Parameters that can be set in the Setting page

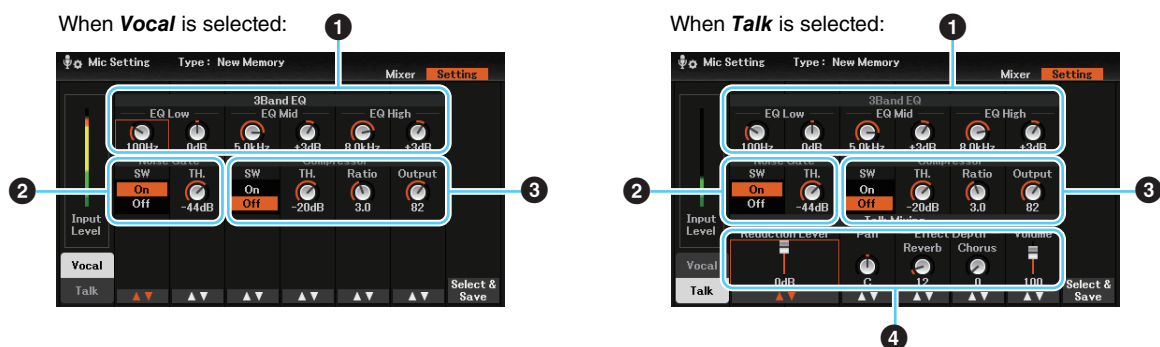

<b>1</b>	<b>3 Band EQ</b>	EQ (Equalizer) is a processor that divides the frequency spectrum into multiple bands which can be boosted or cut as required to tailor the overall frequency response. The instrument features a three-band (Low, Mid and High) digital equalizer function for the microphone sound. For each of three bands, you can adjust the center frequency (Hz) and level (dB) via the corresponding knobs on the display.
<b>2</b>	<b>Noise Gate</b>	This effect mutes the input signal when the input from the microphone falls below a specified level. This effectively cuts off extraneous noise, allowing the desired signal (vocal, etc.) to pass.
	<b>SW (Switch)</b>	Turns the Noise Gate on or off.
	<b>TH. (Threshold)</b>	Adjusts the input level above which the gate begins to open.
<b>3</b>	<b>Compressor</b>	This effect holds down the output when the input signal from the microphone exceeds a specified level. This is especially useful for smoothing out vocals that have widely varying dynamics. It effectively “compresses” the signal, making soft parts louder and loud parts softer.
	<b>SW (Switch)</b>	Turns Compressor on or off.
	<b>TH. (Threshold)</b>	Adjusts the input level above which compression begins to be applied.
	<b>Ratio</b>	Adjusts the compression ratio. Higher ratios result in a more compressed sound, with a reduced dynamic range.
	<b>Output</b>	Adjusts the final output level.

4	<b>Talk Mixing</b>	Lets you make settings for talking or making announcements between songs during a performance.
	<b>Reduction Level</b>	Determines the amount of reduction to be applied to the overall sound (excepting the microphone input)—allowing you to effectively adjust the balance between your voice and the overall instrument sound.
	<b>Pan</b>	Determines the stereo pan position of the microphone sound.
	<b>Effect Depth</b>	Determines the depth of the <b>Reverb</b> or <b>Chorus</b> effects applied to the microphone sound.
	<b>Volume</b>	Determines the output volume of the microphone sound.

## Applying Desired Effects to the Microphone Sound

In addition to Reverb and Chorus, a wide variety of Effect Types are provided. You can select the desired effect type in the display called up via [MIC SETTING] → TAB [◀] **Mixer** → [8 ▲▼] (**DSP**).

The parameters and operations on this display are the same as those in the **Mixer** display called up via the [MIXER/EQ] button. For details, refer to [page 69](#). If you want to apply the effect only to the microphone sound, make sure to select **DSP 5** as an effect block, and **Mic** as a part.

To save the settings you've made on the **Mixer** page of the **Mic Setting** display, register them to Registration Memory.

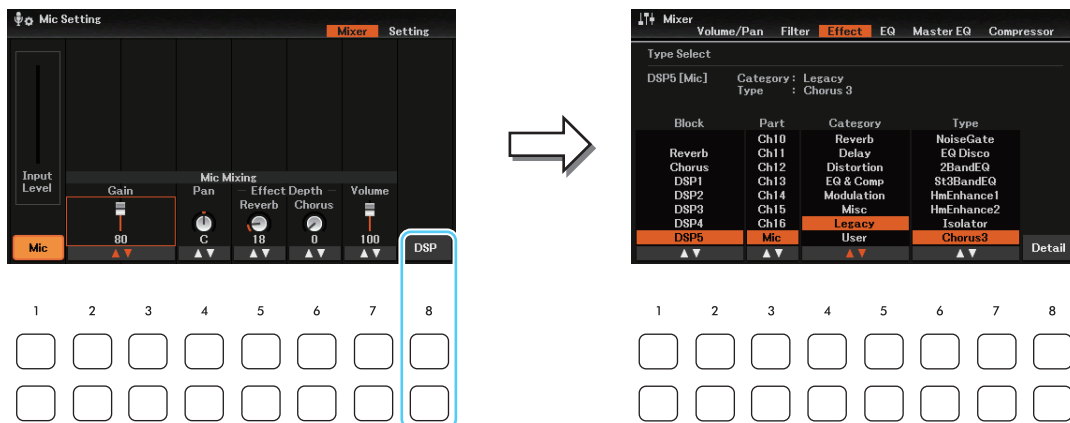

# Registration Memory/Playlist

## Contents

Deleting or Renaming the Registration Memory .....	61
Disabling Recall of Specific Items (Freeze) .....	62
Calling Up Registration Memory Numbers in Order (Registration Sequence) .....	63
• Program a Registration Sequence .....	63
• Using the Registration Sequence .....	65
Copying the Playlist Records from Another Playlist (Append Playlist) .....	65

## Deleting or Renaming the Registration Memory

You can rename or delete each Registration Memory number (1 – 4) contained in the Bank.

- 1 Press the REGISTRATION MEMORY [BANK] button to call up the Registration Bank Selection display, and then select the desired Bank file.

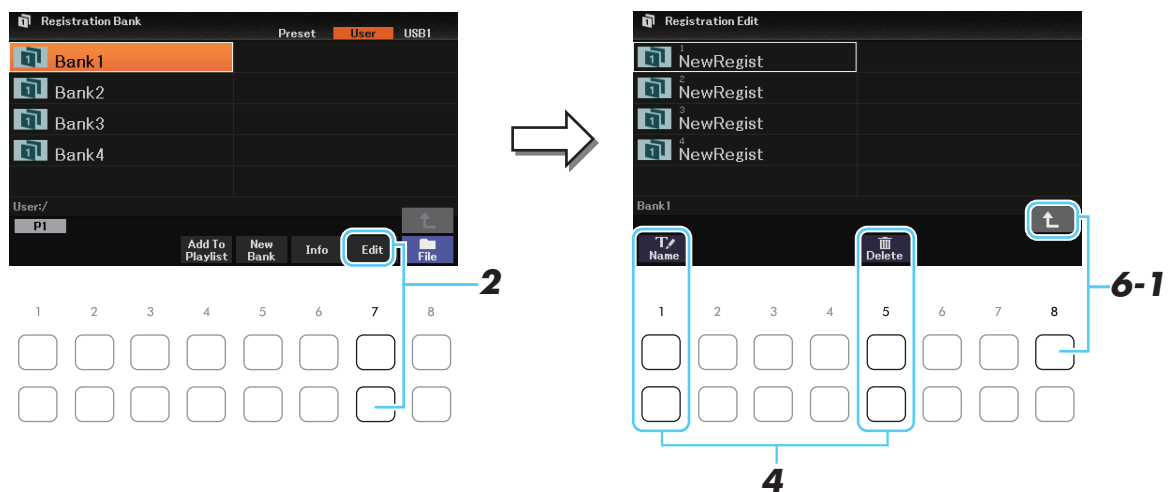

- 2 Press the [7 ▼] (*Edit*) button to call up the *Registration Edit* display.

**NOTE** If the button is not shown, press the [8 ▼] (*Close*) button to call it up.

**NOTE** You can call up the information window to confirm which Voices and Style are memorized to the [1] – [4] buttons of a Registration Memory Bank by pressing the [6 ▼] (*Info*) button. The display consists of two pages: Voice related and Style-related. You can alternate between the two by using the TAB [◀][▶] buttons.

- 3 Select the desired Registration Memory number.
- 4 Press the [1 ▼] (*Name*) button to rename or [5 ▼] (*Delete*) button.
- 5 Select the desired Registration Memory number to rename or delete.
- 6 Save the current Bank containing the edited Registration Memories.
  - 6-1 Press the [8 ▲] button to return to the Registration Bank Selection display.
  - 6-2 Press the [8 ▼] (*File*) button, and then press the [6 ▼] (*Save*) button to save the Bank file.

## Disabling Recall of Specific Items (Freeze)

Registration Memory lets you recall all the panel setups you made with a single button press. However, there may be times that you want certain items to remain the same, even when switching Registration Memory setups. When you want to switch the Voice settings but still maintain the Style settings, for example, you can “freeze” only the Style settings and have those Style settings remain, even when you select another Registration Memory number.

### 1 Call up the operation display.

[MENU] → Cursor buttons [▲][▼][◀][▶] *Regist Sequence/Freeze*, [ENTER] → TAB [▶] *Freeze*

### 2 Use the Cursor buttons [▲][▼][◀][▶] to select the item to be registered, and then press the [ENTER] button to enter (or remove) the corresponding checkmark.

Items having checkmarks will be frozen when the Freeze function is turned on.

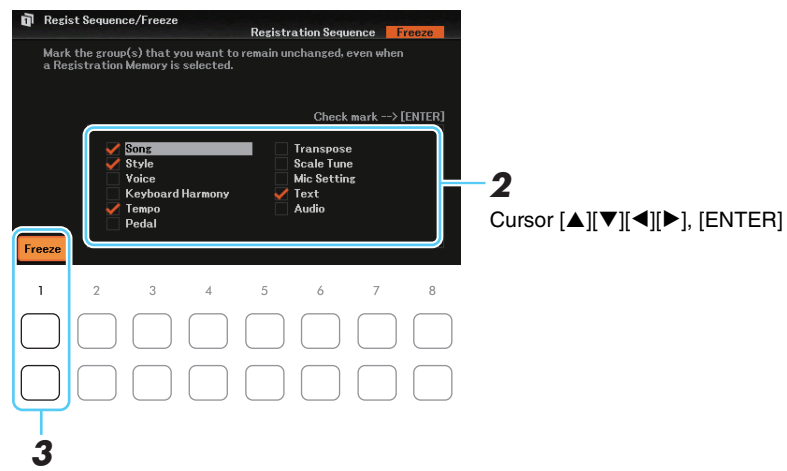

### 3 Use the [1 ▲▼] (*Freeze*) buttons to turn the Freeze function on.

With this operation, you can “freeze” or maintain checkmarked items, even when you select another Registration Memory number. To turn off the Freeze function, use the [1 ▲▼] (*Freeze*) buttons again.

### 4 Press the [EXIT] button to exit from the operation display.

#### **NOTICE**

Settings in the *Freeze* display are automatically saved to the instrument when you exit from this display. However, if you turn the power off without exiting from this display, the settings will be lost.

## Calling Up Registration Memory Numbers in Order (Registration Sequence)

As convenient as the Registration Memory buttons are, there may be times during a performance when you want to quickly switch between settings. The convenient Registration Sequence function lets you call up the four setups in any order you specify, by simply using the TAB [◀][▶] buttons (in the Main display) or the pedal as you play.

### Program a Registration Sequence

- 1** If you intend to use a pedal or pedals to switch the Registration Memory number, connect a pedal or pedal unit to the [AUX PEDAL] jack or the [PEDAL UNIT] jack.
- 2** Press the REGISTRATION MEMORY [BANK] button to call up the Registration Bank Selection display, and then select the desired Bank to be programmed.
- 3** Call up the operation display.  
[MENU] → Cursor buttons [▲][▼][◀][▶] *Regist Sequence/Freeze*, [ENTER] → TAB [◀] *Registration Sequence*.
- 4** If you use a pedal, specify here how the pedal will be used—to advance or to reverse through the sequence.

Use the [8 ▲▼] (*Pedal*) buttons to call up the operation window.

- [5 ▲▼]/[6 ▲▼] (*Prev.*): Selects which pedal is used for reversing the Registration Sequence.
- [7 ▲▼]/[8 ▲▼] (*Next*): Selects which pedal is used for advancing the Registration Sequence.

*AUX* indicates the pedal connected to the [AUX PEDAL] jack, while *Right*, *Center* and *Left* indicate the pedals of the pedal unit connected to the [PEDAL UNIT] jack.

Indicates the name of the currently selected Registration Memory Bank.

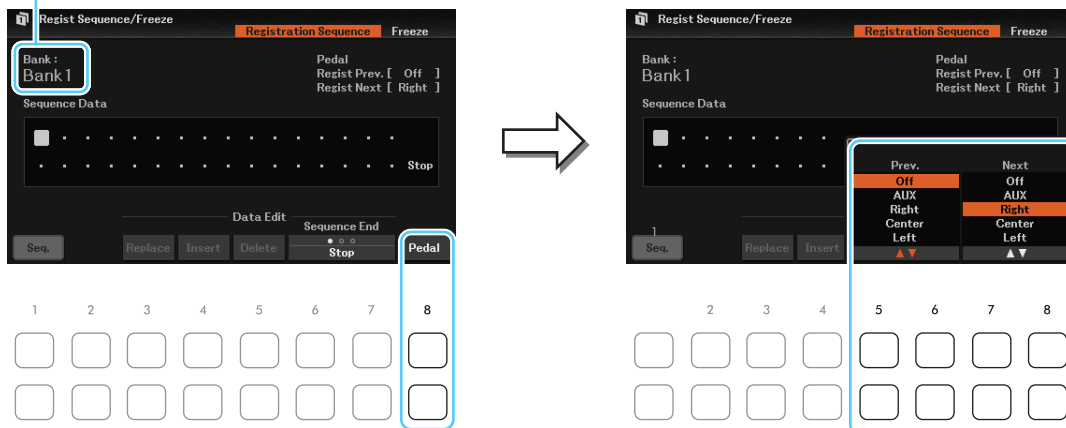

Note that the pedal settings here (other than *Off*) will take priority over the settings in the *Pedal* page of the *Controller* display (page 75). If you want to use the pedal for a function other than Registration Sequence, make sure to set this to *Off*.

After making setups, press the [EXIT] button to close the window.

## 5 Program the Sequence order, from left to right.

Press one of the REGISTRATION MEMORY [1]–[4] buttons on the panel, and then use the [4 ▲▼] (*Insert*) buttons to input the number. The Cursor position can be moved by using the Cursor buttons [▲][▼][◀][▶].

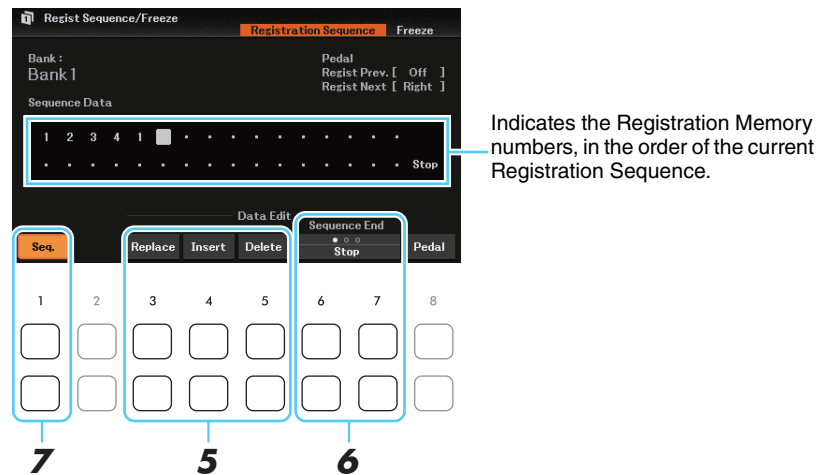

[3 ▲▼]	<i>Replace</i>	Replaces the number at the cursor position with the currently selected Registration Memory number.
[4 ▲▼]	<i>Insert</i>	Inserts the number of the currently selected Registration Memory number to the cursor position.
[5 ▲▼]	<i>Delete</i>	Deletes the number at the cursor position.

## 6 Press one of the [6 ▲▼]/[7 ▲▼] (*Sequence End*) buttons repeatedly to determine how Registration Sequence behaves when reaching the end of the sequence.

- **Stop**..... Pressing the TAB [▶] button or the “advance” pedal has no effect. The sequence is “stopped.”
- **Top**..... The sequence starts again at the beginning.
- **Next Bank**..... The sequence automatically moves to the beginning of the next Registration Memory Bank in the same folder.

## 7 Use the [1 ▲▼] (*Seq.*) buttons to turn the Registration Sequence function on.

## 8 Press the [EXIT] button to save the Registration Sequence settings as part of the current Registration Bank file.

When a message appears asking you to change the settings, use the [7 ▲▼] (*Yes*) buttons to actually save the sequence data.

### **NOTICE**

Settings in the Registration Sequence display will be lost if you select another Registration Bank without carrying out the Save operation.



## Using the Registration Sequence

- 1 Select the desired Registration Bank and make sure that the Registration Sequence function is turned on.
- 2 On the Main display, confirm the Registration Sequence.

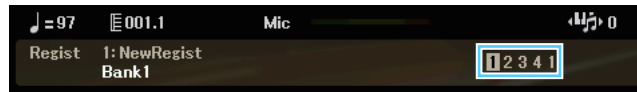

**NOTE** When the Registration Sequence is turned on, the numbers 1–4 are shown even if the sequence has not been programmed.

- 3 Press the TAB [◀] or [▶] button, or press the pedal to select the first Registration Memory number.

The selected number is highlighted.

- 4 Use the TAB buttons or pedal during your keyboard performance.

To return to the status in which no Registration Memory number is selected, press the TAB [◀] and [▶] buttons simultaneously while the Main display is shown.

**NOTE** The pedal can be used for Registration Sequence even when the Main display is not shown.

**NOTE** You can also assign the other functions to the pedal — Punch In/Out of Song (page 53) and the function set in the *Pedal* page of the *Controller* display (page 75). If you assign multiple functions to the pedal, the priority is: Punch In/Out of Song → Registration Sequence → the function set in the *Pedal* page of the *Controller* display.

## Copying the Playlist Records from Another Playlist (Append Playlist)

“Append Playlist” allows you to copy the existing Playlist file and add it to the current Playlist file.

- 1 On the Playlist display, use the [8 ▲▼] (Option) buttons to call up the operation window.

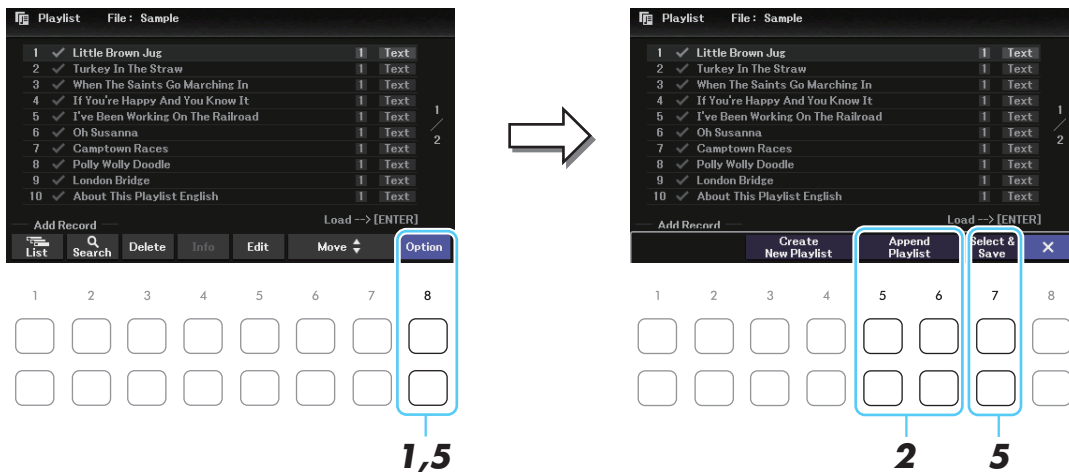

- 2 Use the [5 ▲▼]/[6 ▲▼] (Append Playlist) buttons to call up the Playlist File Selection display.
- 3 Select the desired Playlist file to append by using the Cursor buttons [▲][▼][◀][▶]. A confirmation message appears. If you want to cancel the operation, press one of the [6 ▲▼] buttons here.
- 4 Use the [7 ▲▼] (Yes) buttons to add the Records.  
All Records in the selected Playlist file are added at the bottom of the current Playlist.
- 5 Use the [8 ▲▼] (Option) buttons to call up the operation window, and then use the [7 ▲▼] (Select & Save) buttons to save the appended Records to the current Playlist file.

## Contents

<b>Editing Volume/Pan Parameters</b> .....	<b>.66</b>
<b>Editing Filter Parameters</b> .....	<b>.67</b>
<b>Editing Effect Parameters</b> .....	<b>.68</b>
• Adjusting the Effect Depth for Each Part .....	<b>.68</b>
• Selecting an Effect Type for each Block .....	<b>.69</b>
• Editing and Saving Your Original Effect Type .....	<b>.70</b>
<b>Editing EQ/Master EQ (Equalizer) Parameters</b> .....	<b>.71</b>
• Editing Part EQ .....	<b>.71</b>
• Editing Master EQ .....	<b>.71</b>
<b>Editing Compressor (Master Compressor) Parameters</b> .....	<b>.73</b>
<b>Block Diagram</b> .....	<b>.74</b>

Regarding the Mixer, the Reference Manual covers detailed descriptions of each parameter while the Owner's Manual covers the basic instructions. After making settings described in this chapter, make sure to save the Mixer settings by following the instructions in the Owner's Manual. Select the part to be edited by pressing the [MIXER/EQ] button repeatedly, and then select the page for the relevant parameters by using the TAB [◀][▶] buttons.

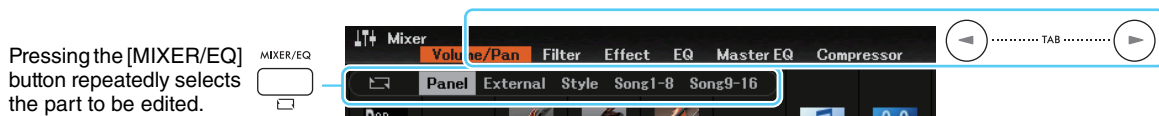

For a visual indication of the signal flow and configuration of the Mixer, refer to the Block Diagram on [page 74](#).

## Editing Volume/Pan Parameters

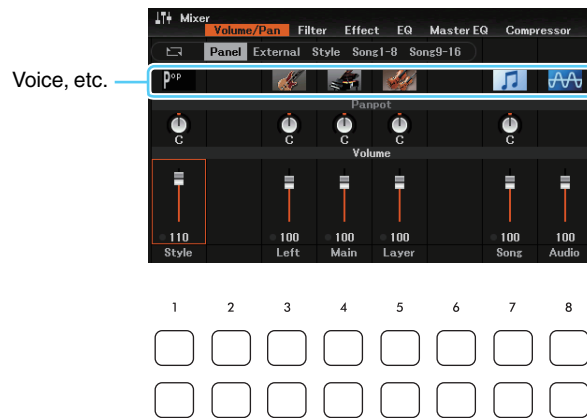

Move the Cursor on the display by using the Cursor buttons [▲][▼][◀][▶], and then use the Data dial or the [1 ▲▼]–[8 ▲▼] buttons to edit parameters.

Voice, etc.	<p>Allows you to re-select the Voices for each keyboard part or each part (channel) of the Style or Song. Press the [1 ▲▼]–[8 ▲▼] buttons to call up the Voice selection page for the part. After selecting the desired Voice, press the [EXIT] button to return to the <b>Mixer</b> display.</p> <p>When the <b>Panel</b> part is selected, the same operation allows you to re-select the Style, Song or Audio file (instead of the Voice) for the corresponding part.</p> <p><b>NOTE</b> When a GM Song is selected, only a Drum Kit Voice can be selected for channel 10 (in the <i>Song Ch9-16</i> page).</p> <p><b>NOTE</b> For a Style or Song channel, calling up a rhythm/percussion Voice (Drum Kit, etc.) will replace the channel settings with those for the new Voice. In such a case, the original settings may not be restored even if you re-select the original Voice. To restore the original sound, select the same Style or Song again without carrying out the Save operation.</p>
<b>Panpot</b>	Determines the stereo position of the selected part (channel).
<b>Volume</b>	Determines the volume of each part or channel, giving you fine control over the balance of all the parts.

## Editing Filter Parameters

This function modifies the tonal characteristics (brightness, etc.) of the sound by cutting the output of a specific frequency portion of the sound.

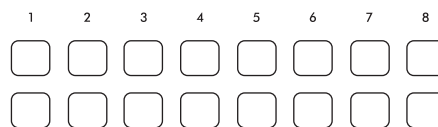

Move the Cursor on the display by using the Cursor buttons [▲][▼][◀][▶], and then use the Data dial or the [1 ▲▼]–[8 ▲▼] buttons to edit parameters.

<b>Harmonic Content</b>	Allows you to adjust the Resonance ( <a href="#">page 15</a> ) for each part.
<b>Brightness</b>	Determines the brightness of the sound for each part by adjusting the Cutoff Frequency ( <a href="#">page 15</a> ).

## Editing Effect Parameters

This instrument features seven Effect Blocks, giving you powerful tools to richly enhance the sounds of the instrument or completely transform them. The Effects are divided into the following groups:

### ■ Reverb, Chorus:

The Effects of these Blocks are applied to the overall sound or all Parts. In each of these Effect Blocks, you can select only one Effect Type at a time and adjust the Send Level (Depth) for each Part as well as the Return Level for all Parts.

### ■ DSP1:

When the *Connection* parameter selected in step 2 of [page 70](#) is set to *System*, the Effects of this Block are applied only to the Style and Song sounds. In this status, you can select only one Effect Type at a time and adjust the Send Level (Depth) for each Part as well as Return Level for all Parts. When the *Connection* parameter is set to *Insertion*, the Effect of this Block is applied to a specific channel of the Style and Song.

### ■ DSP2-5:

The Effects of these Blocks are applied to a specific Part or Channel. Different Effect Types can be selected for each of the available Parts or Channels.

## Adjusting the Effect Depth for Each Part

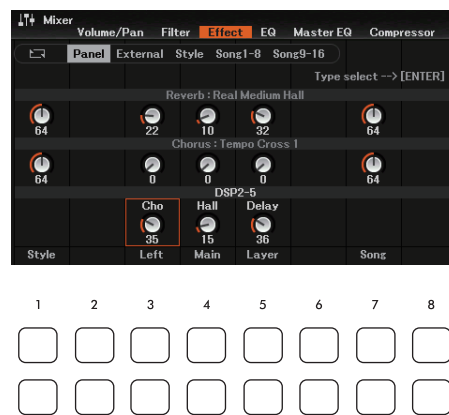

Use the Cursor buttons [▲][▼][◀][▶] to select the desired Effect Block, and then use the Data dial or the [1 ▲▼]–[8 ▲▼] buttons to adjust the Effect Depth for each Part.

# Selecting an Effect Type for each Block

**1** In the *Effect* page, press the [ENTER] button to call up the *Type Select* display.

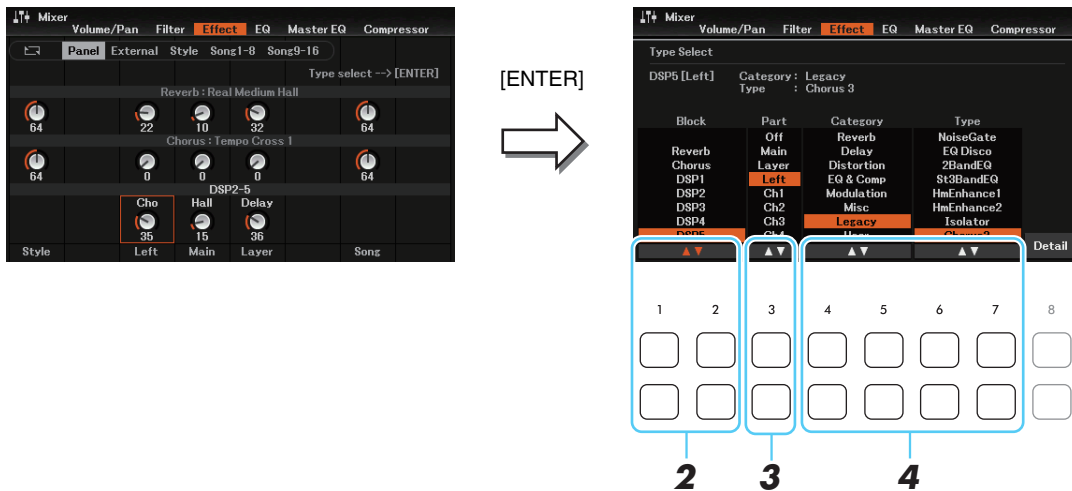

**2** Use the [1 ▲▼]/[2 ▲▼] (*Block*) buttons to select the **Effect Block**.

Effect Block	Effect-applicable parts	Effect characteristics
<i>Reverb</i>	All parts	Recreates the warm ambience of playing in a concert hall or jazz club.
<i>Chorus</i>	All parts	Produces a richly textured sound as if several parts are being played simultaneously. In addition, other type effects (such as reverb, delay, etc.) can also be selected in this effect block.
<i>DSP1</i>	Style part, Song channel 1–16	In addition to Reverb and Chorus, a wide variety of Effect Types are provided, such as Distortion. This effect is applied only to Style/Song parts. When the <b>Connection</b> parameter selected in step 2 of <a href="#">page 70</a> is set to <b>System</b> , the DSP1 effect will be applied overall to the Style and Song. When it is set to <b>Insertion</b> , the DSP1 effect will be applied to a specific part of the Style or Song.
<i>DSP2</i> , <i>DSP3</i> , <i>DSP4</i> , <i>DSP5</i>	Main, Layer Left, Song channel 1–16, Mic*	In addition to Reverb and Chorus, a wide variety of Effect Types are provided, such as Distortion. For each of DSP2–5, you can select one of the Parts or Channels listed at left. When you select <b>Layer</b> for DSP2, for example, the DSP2 Effect is applied only to the Layer part. Note that if you select a Song or Style which needs the DSP2–5 Blocks, the Part assignment of these three Blocks will be changed automatically with last priority according to the data. * The Mic part can only be processed with <i>DSP5</i> . If you want to apply a certain Effect only to the microphone sound, use <i>DSP5</i> and select <i>Mic</i> .

**3** Use the [3 ▲▼] (*Part*) buttons to select the **Part** to which you want to apply the effect.

Note that a Part cannot be selected if *Reverb*, *Chorus*, or *DSP1* (when the **Connection** parameter is set to **System** in step 2 on [page 70](#)) is selected. This is because only one of the Effect Types can be selected to be commonly applied to all available Parts.

**4** Use the [4 ▲▼]/[5 ▲▼] (*Category*) buttons to select the **Effect Category**, and then use the [6 ▲▼]/[7 ▲▼] (*Type*) buttons to select the **Effect Type**.

Note that the Reverb Block is not divided into any Categories.

If you want to edit detailed Parameters of the selected Effect Type, press one of the [8 ▲▼] (*Detail*) buttons. For details, refer to the next section.

## Editing and Saving Your Original Effect Type

- Once you've selected an Effect Block and Effect Type in the previous section, use the [8 ▲▼] (*Detail*) buttons to call up the display for editing the effect parameters.

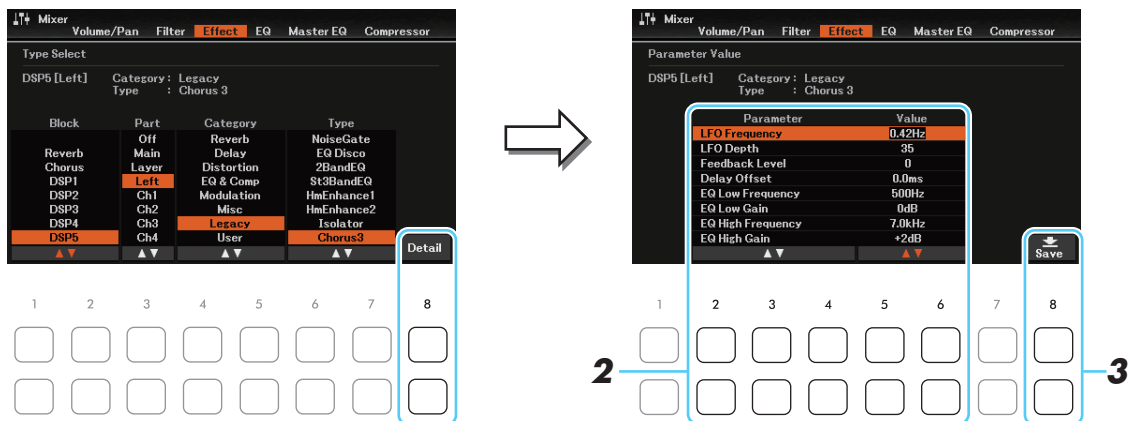

- Use the [2 ▲▼]–[4 ▲▼] (*Parameter*) buttons to select a parameter, and then use the [5 ▲▼]/[6 ▲▼] (*Value*) buttons to edit the value.

When *Reverb*, *Chorus*, or *DSP1* is selected as the Effect Block, you can adjust the Return Level via the [7 ▲▼] (*Effect Return Level*) buttons.

- Press one of the [8 ▲▼] (*Save*) buttons to call up the *User Effect* display for the *Save* operation.

- Use the [2 ▲▼]–[5 ▲▼] (*Memory*) buttons to select the destination for saving the settings as a *User Effect*.

If necessary, change the User Effect name. Press one of the [6 ▲▼] (*Rename*) buttons to call up the Character Entry window, enter the name, and then press the [8 ▲] (*OK*) button.

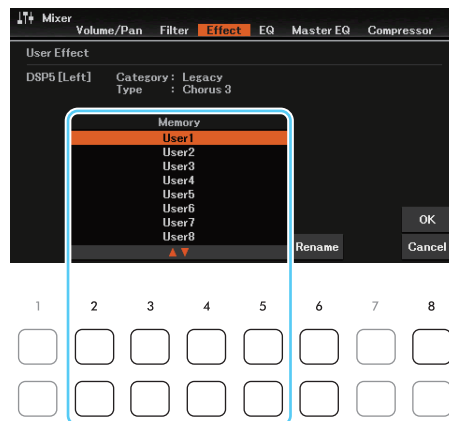

- Press the [8 ▲] (*OK*) button to carry out the *Save* operation.

To return to the previous display, press the [EXIT] button.

To call up the User Effect saved here, select the *User* category of the corresponding Effect Block in step 4 on [page 69](#).

## Editing EQ/Master EQ (Equalizer) Parameters

Equalizer (also called “EQ”) is a sound processor that divides the frequency spectrum into multiple bands that can be boosted or cut as required to tailor the overall frequency response.

The *EQ* page selected by using the TAB [◀][▶] buttons lets you adjust the EQ for each corresponding part, while the *Master EQ* page lets you make overall EQ adjustments for the entire instrument. The *Master EQ* page can also be called up directly from any display by pressing the [MIXER/EQ] and [CHANNEL ON/OFF] buttons simultaneously.

### Editing Part EQ

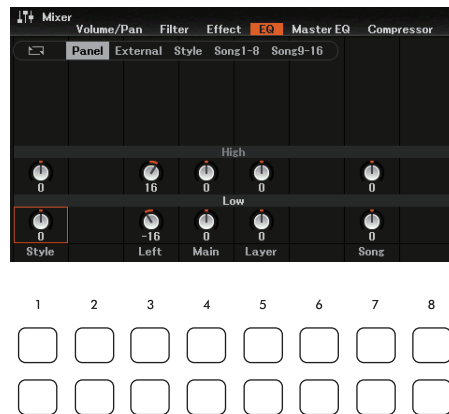

Move the Cursor on the display by using the Cursor buttons [▲][▼][◀][▶], and then use the Data dial or the [1 ▲▼]–[8 ▲▼] buttons to edit parameters.

<b>High</b>	Boosts or attenuates the high EQ band for each part.
<b>Low</b>	Boosts or attenuates the low EQ band for each part.

### Editing Master EQ

The instrument possesses a high-quality five-band digital EQ. With this function, a final effect—tone control—can be added to the output of your instrument. You can select one of the five preset EQ settings in the *Master EQ* page. You can even create your own custom EQ settings by adjusting the frequency bands, and save the settings as User Master EQ types.

**NOTE** Master EQ cannot be applied to playback of audio received via the USB Audio Player function or the Audio Input Sounds.

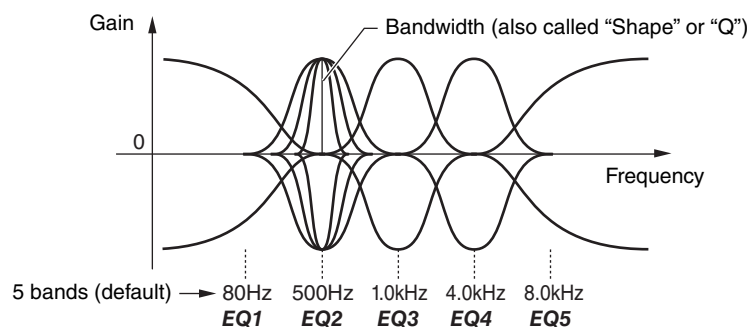

# 1 Use the [1 ▲▼] (Type) buttons to call up the *Master EQ Type* window.

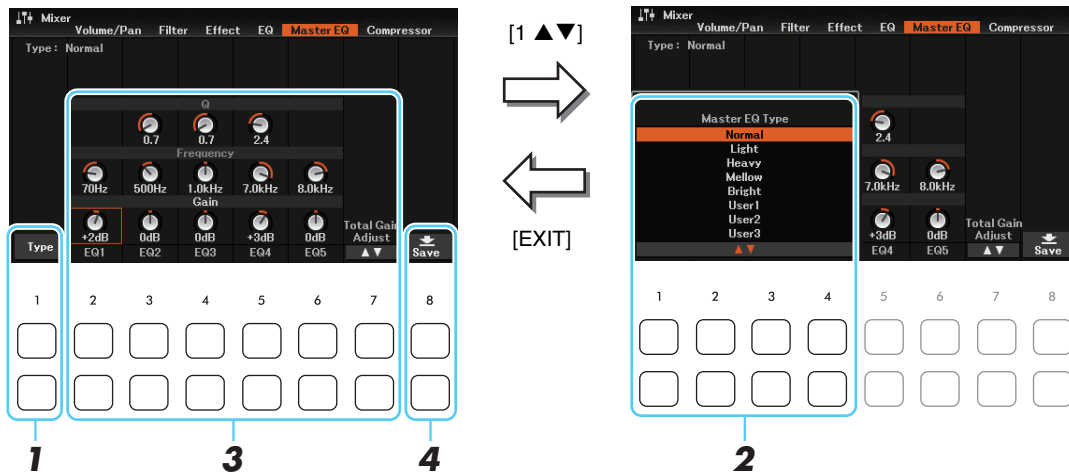

# 2 Use the [1 ▲▼] – [4 ▲▼] buttons to select the desired Master EQ type, and then press the [EXIT] button.

- **Normal:** Normal EQ settings in which the instrument's characteristics are optimally brought out.
- **Light:** EQ setting for decreasing the level of the low frequencies, making the sound clearer.
- **Heavy:** EQ setting for boosting the level of the low frequencies, making the sound more powerful.
- **Mellow:** EQ setting for decreasing the level of the high frequencies, making the sound more mellow.
- **Bright:** EQ setting for boosting the level of the high frequencies, making the sound brighter.
- **User 1–30:** Your own custom EQ settings saved in step 5.

# 3 Use the Cursor buttons [▲][▼][◀][▶] to move the cursor to the desired position, and then use the Data dial or the [2 ▲▼]–[6 ▲▼] buttons to adjust the *Gain* level of each band as well as the *Q* (bandwidth) and the *Frequency* (center frequency).

You can boost or cut all the five bands at the same time by using the [7 ▲▼] (*Total Gain Adjust*) buttons. The higher the value of *Q*, the narrower the bandwidth. The available Frequency range is different for each band.

# 4 Press one of the [8 ▲▼] (Save) buttons to call up the *User Master EQ* display for the Save operation.

# 5 Use the [2 ▲▼]–[5 ▲▼] buttons to select the destination for saving the settings as a *User Master EQ* type.

If necessary, change the Master EQ name. Use the [6 ▲▼] (*Rename*) buttons to call up the Character Entry window, enter the name, and then press the [8 ▲] (*OK*) button. The Master EQ setting saved here can be selected as described in step 1–2.

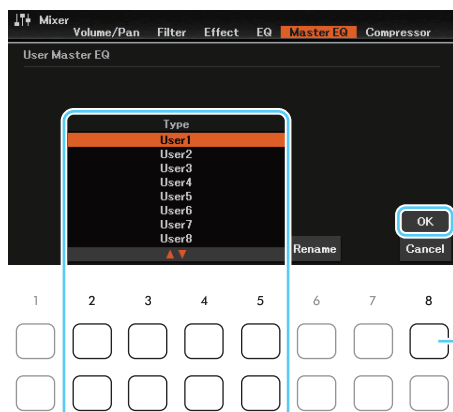



## Editing Compressor (Master Compressor) Parameters

Compressor is an effect commonly used to limit and compress the dynamics (softness/loudness) of an audio signal. For signals that vary widely in dynamics, such as vocals and guitar parts, it “squeezes” the dynamic range, effectively making soft sounds louder and loud sounds softer. When used with gain to boost the overall level, this creates a more powerful, more consistently high-level sound.

This instrument features the Master Compressor applied to the entire sound of this instrument. Although the preset Master Compressor settings are provided, you can create and save your original Master Compressor by adjusting the related parameters.

**NOTE** Master Compressor cannot be applied to playback of audio received via the USB Audio Player function and the Audio Input Sounds.

### 1 Use the [1 ▲▼] (CMP) buttons to turn the Master Compressor on.

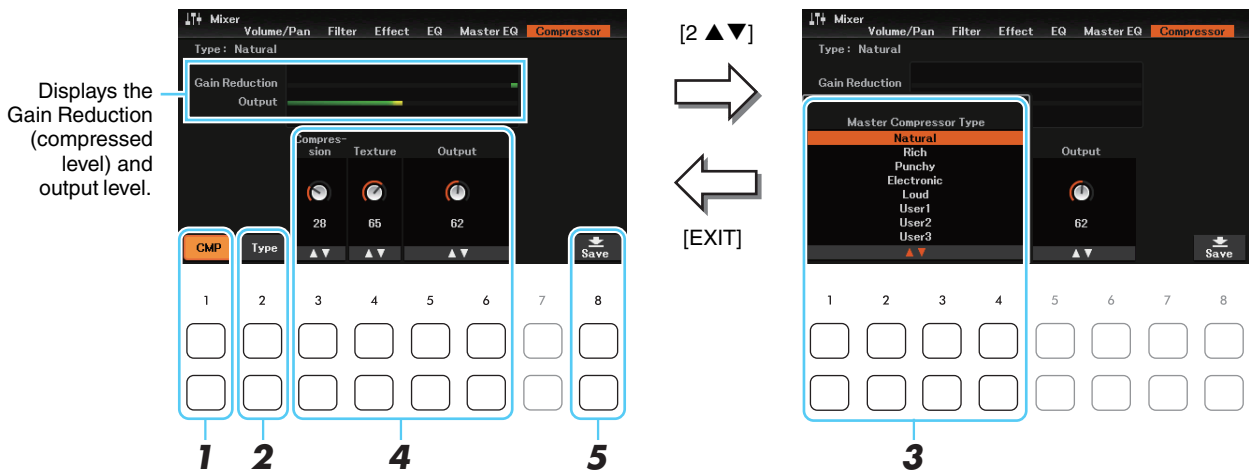

### 2 Use the [2 ▲▼] (Type) buttons to call up the Master Mixer Compressor Type window.

### 3 Use the [1 ▲▼] – [4 ▲▼] buttons to select the Master Compressor type, and then press the [EXIT] button.

- **Natural:** Natural Compressor settings in which the effect is moderately pronounced.
- **Rich:** Rich Compressor settings in which the instrument’s characteristics are optimally brought out. This is good for enhancing acoustic instruments, jazz music, etc.
- **Punchy:** Highly exaggerated Compressor settings. This is good for enhancing rock music.
- **Electronic:** Compressor settings in which the electronic dance music’s characteristics are optimally brought out.
- **Loud:** Powerful Compressor settings. This is good for enhancing energetic music such as rock or gospel music.
- **User 1–30:** Your own custom Master Compressor settings saved in step 5.

### 4 Edit the Master Compressor.

[3 ▲▼]	<b>Compression</b>	Determines the threshold (minimum level at which compression starts).
[4 ▲▼]	<b>Texture</b>	Determines the ratio of compression (how much the dynamic range is compressed).
[5 ▲▼]/ [6 ▲▼]	<b>Output</b>	Determines the output level.

- 5 Press one of the [8 ▲▼] (Save) buttons to call up the *User Master Compressor* display for the Save operation.
- 6 Use the [2 ▲▼]–[5 ▲▼] buttons to select the destination for saving the settings as a *User Master Compressor type*.

If necessary, change the Master Compressor name. Use the [6 ▲▼] (*Rename*) buttons to call up the Character Entry window, enter the name, and then press the [8 ▲] (*OK*) button. The Master Compressor setting saved here can be selected as described in step 2–3.

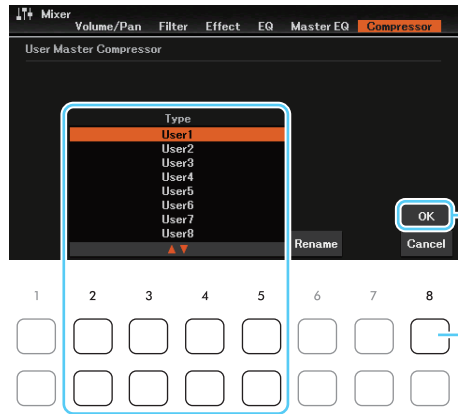

## Block Diagram

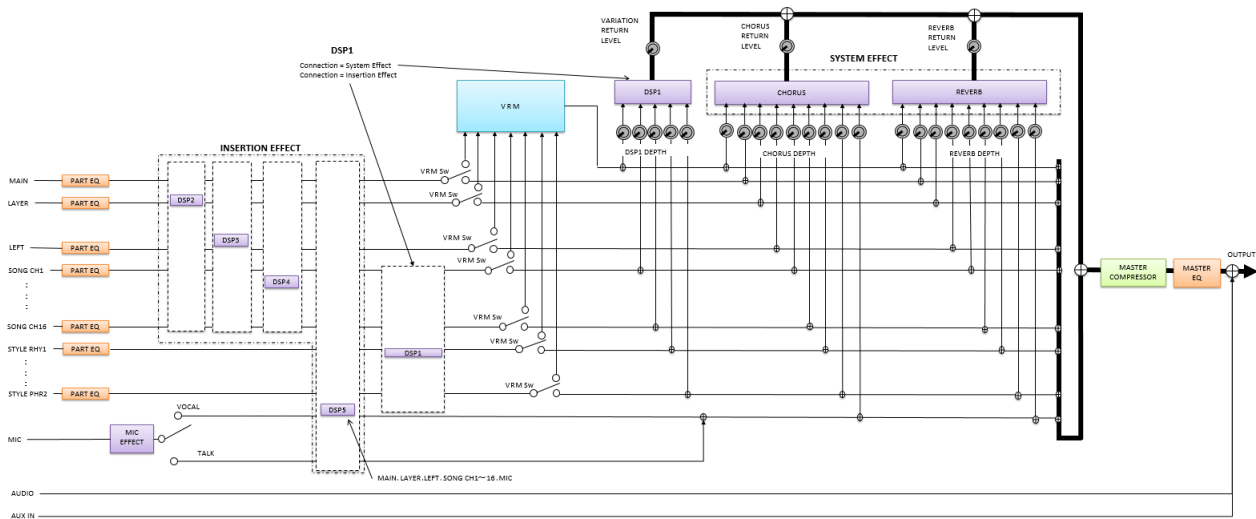

## Contents

<b>Assigning a Specific Function to Each Pedal</b> .....	<b>.75</b>
• Assignable Pedal Functions .....	.76
<b>MIDI Settings</b> .....	<b>.79</b>
• MIDI System Settings .....	.80
• MIDI Transmit Settings .....	.82
• MIDI Receive Settings .....	.83
• Bass Note Settings for Style Playback via MIDI Receive .....	.84
• Chord Type Settings for Style Playback via MIDI Receive .....	.84
<b>Making Wireless LAN Settings</b> .....	<b>.85</b>
• Infrastructure Mode .....	.85
• Access Point Mode .....	.86

## Assigning a Specific Function to Each Pedal

The functions of the pedal connected to the [AUX PEDAL] jack and the pedals of the pedal unit connected to the [PEDAL UNIT] jack can be changed individually from the default settings (sustain, etc.).

**NOTE** For information on connecting a pedal or a pedal unit, refer to “Panel Controls and Terminals” on the Owner’s Manual.

### 1 Call up the operation display.

[MENU] → Cursor buttons [▲][▼][◀][▶] *Controller*, [ENTER] → TAB [◀] *Pedal*

### 2 Use the Cursor buttons [▲][▼] to select the pedals to which the function is to be assigned.

1 *AUX* is the function for the pedal connected to the [AUX PEDAL] jack, and 2 *Right*, 3 *Center*, 4 *Left* are for the pedals of the pedal unit connected to the [PEDAL UNIT] jack.

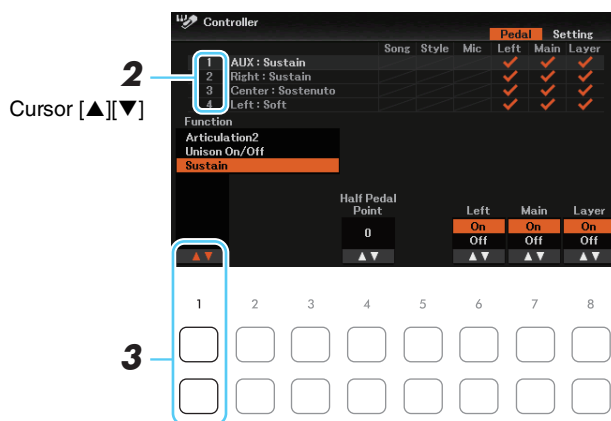

### 3 Use the [1 ▲▼] buttons to select the function to be assigned to the pedal specified in step 2.

For information on available functions, see [pages 76–78](#).

**NOTE** You can also assign other functions to the pedal—Punch in/out of Song ([page 53](#)) and Registration Sequence ([page 63](#)). If you assign multiple functions to the pedal, the priority is: Punch in/out of Song → Registration Sequence → Functions assigned here.

**4** Use the [2 ▲▼]–[8 ▲▼] buttons to set the details of the selected functions (the part for which the function is applied, etc.).

The available parameters differ depending on the function selected in step 3.

**5** If necessary, make the following settings on the display called up via TAB [▶] **Setting** → **Cursor** button [▼] 3.

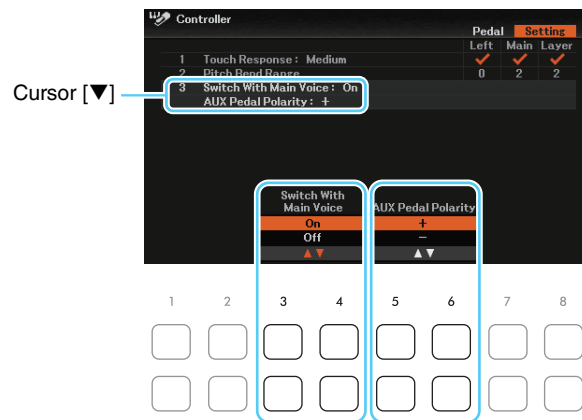

[3 ▲▼] – [4 ▲▼]	<b>Switch with Main Voice</b>	When this is set to <b>Off</b> , the function assignments of the Center and Left pedals of the pedal unit connected to the [PEDAL UNIT] jack are maintained even if the Main Voice is changed (page 14).
[5 ▲▼] – [6 ▲▼]	<b>AUX Pedal Polarity</b>	Pedal on/off operation may differ depending on the particular pedal you've connected to the [AUX PEDAL] jack. For example, pressing down on one pedal may turn the selected function on, while pressing a different make/brand of pedal may turn the function off. If necessary, use this setting to reverse the operation.

## Assignable Pedal Functions

For functions indicated with “\*”, use the separately sold pedal FC3A or the pedal unit LP-1B/LP-1WH; proper operation cannot be done with a footswitch.

<b>Articulation 1, 2</b>	When you use a Super Articulation Voice that has an effect assigned to the pedal, you can enable the effect by pressing the pedal. You can turn this pedal function on or off for each keyboard part on this display.
<b>Unison On/Off</b>	Allows you to use a pedal to turn the Unison function on/off.
<b>Sustain</b>	Allows you to use a pedal to control sustain. When you press and hold the pedal, all notes played on the keyboard have a longer sustain. Releasing the pedal immediately stops (damps) any sustained notes. You can turn this pedal function on or off for each keyboard part on this display. The <b>Half Pedal Point</b> parameter allows you to specify how far down you should press on the pedal until the damper effect starts working.
<b>Sostenuto</b>	Allows you to use a pedal to control the Sostenuto effect. If you play a note or chord on the keyboard and press the pedal while holding the note(s), the notes will sustain as long as the pedal is held. However, all subsequent notes will not sustain. This makes it possible to sustain a chord, for example, while other notes are played staccato. You can turn this pedal function on or off for each keyboard part on this display.
<b>Soft</b>	Allows you to use a pedal to control the Soft effect. Pressing this pedal reduces the volume and changes the timbre of the notes you play. This is effective only for certain appropriate Voices. You can turn this pedal function on or off for each keyboard part on this display. The <b>Half Pedal Point</b> parameter allows you to specify how far down you should press on the pedal until the soft effect starts working.

<b><i>Glide Up, Glide Down</i></b>	<p>When the pedal is pressed, the pitch goes up (is raised) or down (is lowered), and then returns to normal pitch when the pedal is released. You can turn this pedal function on or off for each keyboard part on this display.</p> <ul style="list-style-type: none"> <li>• <b>Range:</b> Determines the range of the pitch change, in semitones.</li> <li>• <b>On Speed:</b> Determines the speed of the pitch change when the pedal is pressed.</li> <li>• <b>Off Speed:</b> Determines the speed of the pitch change when the pedal is released.</li> </ul>
<b><i>Portamento</i></b>	<p>The portamento effect (a smooth slide between notes) can be produced while the pedal is pressed. Portamento is produced when notes are played legato style (i.e., a note is played while the preceding note is still held). This function does not affect certain Natural! Voices, which would not sound appropriately with this function. You can turn this pedal function on or off for each keyboard part on this display. The portamento time can also be adjusted from the <b>Voice Set</b> display (page 13).</p>
<b><i>Pitch Bend Up*, Pitch Bend Down*</i></b>	<p>Allows you to bend the pitch of notes up or down by using the pedal. You can turn this pedal function on or off for each keyboard part on this display.</p> <ul style="list-style-type: none"> <li>• <b>Range:</b> Determines the range of the pitch change, in semitones.</li> </ul>
<b><i>Modulation*</i></b>	<p>Applies modulation effects, such as vibrato, to notes played on the keyboard. Moreover, various effects can be added to the Super Articulation Voice. The effect becomes deeper when pressing down the pedal. You can turn this pedal function on or off for each keyboard part on this display.</p>
<b><i>Modulation Alt</i></b>	<p>Unlike the <b>Modulation</b> above, pressing the pedal or footswitch alternates the on/off status of the vibrato effect. You can turn this function on or off for each keyboard part on this display.</p>
<b><i>Vibe Rotor On/Off</i></b>	<p>Switches the Vibe Rotor on and off when the DSP Type (page 16) is set to <b>Vibe Rotor</b>. You can turn this pedal function on or off for each keyboard part on this display.</p>
<b><i>Organ Rotary Slow/ Fast</i></b>	<p>Switches the Rotary Speaker speed between “Slow” and “Fast.” This can be used only when an organ effect (page 68) such as “<b>RotarySp1</b>” is applied. You can turn this pedal function on or off for each keyboard part on this display.</p> <p><b>NOTE</b> Since the Super Articulation Voices contain the effect as part of the wave data, you need to assign <i>Articulation 1 or 2</i> (not <i>Organ Rotary Slow/Fast</i>) to control the effect.</p>
<b><i>Keyboard Harmony On/Off</i></b>	<p>Turns Keyboard Harmony (page 7) on and off.</p>
<b><i>Style Start/Stop</i></b>	<p>Same as the STYLE CONTROL [START/STOP] button.</p>
<b><i>Synchro Start On/ Off</i></b>	<p>Same as the [SYNC START] button.</p>
<b><i>Synchro Stop On/ Off</i></b>	<p>Turns on/off the Synchro Stop function which allows you to start and stop the Style anytime you want by simply playing or releasing the keys in the chord section of the keyboard. Make sure that the [ACMP] button is on, and then turn this function on to use this function.</p> <p><b>NOTE</b> When the Fingering type is set to <i>Full Keyboard</i> or <i>All Full Keyboard</i>, Synchro Stop cannot be turned on.</p>
<b><i>Intro 1–3</i></b>	<p>Same as the [INTRO] button. Three types of the Intro section are provided for each Style and one of them can be assigned to the pedal.</p>
<b><i>Main A–D</i></b>	<p>Same as the MAIN VARIATION [A]–[D] buttons.</p>
<b><i>Fill Down</i></b>	<p>Plays a fill-in, which is automatically followed by the previous Main section (that of the button on the immediate left).</p>
<b><i>Fill Self</i></b>	<p>Plays a fill-in.</p>
<b><i>Fill Break</i></b>	<p>Plays a break.</p>

<b>Fill Up</b>	Plays a fill-in, followed by the next Main section (that of the button on the immediate right).
<b>Ending1–3</b>	Same as the [ENDING/rit.] button. Three types of the Ending section are provided for each Style and one of them can be assigned to the pedal.
<b>Half Bar Fill In</b>	While the pedal is pressed, the “Half bar fill-in” function is turned on and changing sections of a Style at the first beat of the current section starts the next section from the middle with automatic fill-in.
<b>Fade In/Out</b>	Switches the Fade In/Fade Out function on and off. This produces smooth fade-ins and fade-outs when starting/stopping Style or Song playback. Press the pedal when playback is stopped and press the STYLE CONTROL [STATR/STOP] button (or the SONG [▶/■] (Play/Pause) button) to start playback with a fade in. To stop playback with a fade out, press the pedal during playback at the appropriate point.
<b>Fingered/ Fingered On Bass</b>	The pedal alternately switches the Chord Fingering types between the <i>Fingered</i> and <i>Fingered On Bass</i> .
<b>Bass Hold</b>	While the pedal is pressed, the Accompaniment Style bass note will be held even if the chord is changed during Style playback. If the fingering is set to <i>AI Full Keyboard</i> , the function does not work.
<b>Song Play/Pause</b>	Same as the SONG [▶/■] (Play/Pause) button.
<b>Score Page +, -</b>	While the Song is stopped, you can turn to the next/previous score page (one page at a time).
<b>Lyrics Page +, -</b>	While the Song is stopped, you can turn to the next/previous lyrics page (one page at a time).
<b>Text Page +, -</b>	You can turn to the next/previous text page (one page at a time).
<b>Talk On/Off</b>	Switches the microphone setup settings between <i>Vocal</i> and <i>Talk</i> .
<b>Tap Tempo</b>	Same as the [TEMPO/TAP] button.
<b>Percussion</b>	The pedal plays a percussion instrument selected by the [4 ▲▼]–[8 ▲▼] buttons. You can use the keyboard to select the desired percussion instrument.  <b>NOTE</b> When you select the percussion instrument by pressing a key on the keyboard, the velocity with which you press the key determines the percussion volume.
<b>Main Part On/Off</b>	Same as the PART ON/OFF [MAIN] button.
<b>Layer Part On/Off</b>	Same as the PART ON/OFF [LAYER] button.
<b>Left Part On/Off</b>	Same as the PART ON/OFF [LEFT] button.

# MIDI Settings

In this section, you can make MIDI-related settings for the instrument. This instrument gives you a set of ten pre-programmed templates that let you instantly and easily reconfigure the instrument to match your particular MIDI application or external device. Also, you can edit the pre-programmed templates and save up to ten of your original templates to the User drive.

**NOTE** You can save all your original templates as a single file to internal memory (User drive) or a USB flash drive. See [page 90](#).

**NOTE** No MIDI signals are received in the Piano Room.

## 1 Call up the operation display.

[MENU] → Cursor buttons [▲][▼][◀][▶] **MIDI**, [ENTER]

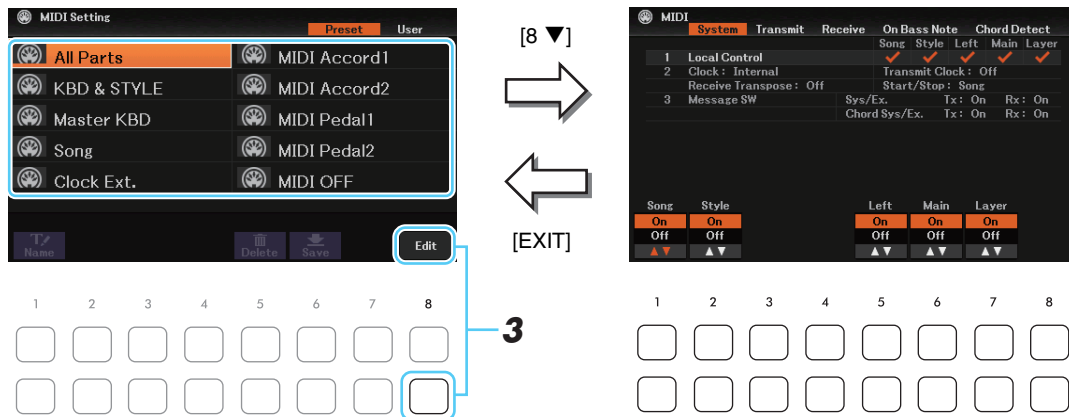

## 2 Select a pre-programmed MIDI template from the *Preset* page.

For details on pre-programmed templates, see below.

If you have already created your original template and saved it to the *User* page, you can also select that template from the *User* page.

## 3 To edit the template, press the [8 ▼] (*Edit*) button to call up the setting display.

## 4 Use the TAB [◀][▶] buttons to call up the relevant page, and then set various parameters to edit the current MIDI template.

- **System**..... MIDI System Settings ([page 80](#))
- **Transmit**..... MIDI Transmit Settings ([page 82](#))
- **Receive** ..... MIDI Receive Settings ([page 83](#))
- **On Bass Note** ..... Bass Note Settings for Style Playback via MIDI Receive ([page 84](#))
- **Chord Detect** ..... Chord Type Settings for Style Playback via MIDI Receive ([page 84](#))

## 5 When you've finished editing, press the [EXIT] button to return to the MIDI Template Selection display.

## 6 Press the TAB [▶] button to select the *User* page, and then press the [6 ▼] (*Save*) button to save the MIDI settings as your original MIDI template.

### ■ Pre-programmed MIDI Templates

<b>All Parts</b>	Transmits all parts including the keyboard parts (Main, Layer and Left), with the exception of Song parts.
<b>KBD &amp; STYLE</b>	Basically the same as <b>All Parts</b> with the exception of how keyboard parts are managed. The right-hand parts are handled together as <b>Upper</b> instead of Main and Layer, and the left-hand part is handled as <b>Lower</b> .

<b>Master KBD</b>	In this setting, the instrument functions as a “master” keyboard, playing and controlling one or more connected tone generators or other devices (such as a computer/sequencer).
<b>Song</b>	All transmit channels are set to correspond to Song channels 1–16. This is used to play Song data with an external tone generator and to record Song data to an external sequencer.
<b>Clock Ext.</b>	Playback or recording (Song, Style, etc.) synchronizes with an external MIDI clock instead of the instrument’s internal clock. This template should be used when you wish to set the tempo on the MIDI device connected to the instrument.
<b>MIDI Accord1</b>	MIDI accordions allow you to transmit MIDI data and play connected tone generators from the keyboard and bass/chord buttons of the accordion. This template lets you play melodies from the keyboard and control Style playback on the instrument with the left-hand buttons.
<b>MIDI Accord2</b>	Basically the same as <b>MIDI Accord 1</b> above, with the exception that the chord/bass notes you play with your left hand on the MIDI Accordion are recognized also as MIDI note events.
<b>MIDI Pedal1</b>	MIDI pedal units allow you play connected tone generators with your feet (especially convenient for playing single note bass parts). This template lets you play/control the chord root in Style playback with a MIDI pedal unit.
<b>MIDI Pedal2</b>	This template lets you play the bass part for Style playback by using a MIDI pedal unit.
<b>MIDI OFF</b>	No MIDI signals are sent or received.

## MIDI System Settings

The explanations here apply to the **System** page in step 4 on [page 79](#).

Use the Cursor buttons [▲][▼] to select the parameters (below), and then set the **On/Off** status by using the [1 ▲▼]–[8 ▲▼] buttons.

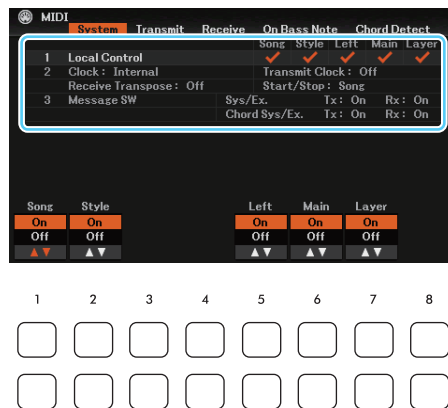

### 1 Local Control

[1 ▲▼] –  
[7 ▲▼]

Turns the Local Control for each part on or off. When Local Control is set to **On**, the keyboard of the instrument controls its own (local) internal tone generator, allowing the internal Voices to be played directly from the keyboard. If you set Local Control to **Off**, the keyboard and controllers are internally disconnected from the instrument’s tone generator section so that no sound is output when you play the keyboard or use the controllers. For example, this allows you to use an external MIDI sequencer to play the instrument’s internal Voices, and use the instrument keyboard to record notes to the external sequencer and/or play an external tone generator.



## 2 Clock setting, etc.

[1 ▲▼]/ [2 ▲▼]	<i>Clock</i>	<p>Determines whether the instrument is controlled by its own internal clock or a MIDI clock signal received from an external device. Internal is the normal Clock setting when the instrument is being used alone or as a master keyboard to control external devices. If you are using the instrument with an external sequencer, MIDI computer, or other MIDI device, and you want to synchronize it to that device, set this parameter to the appropriate setting: <i>USB1</i>, <i>USB2</i> or <i>Wireless LAN</i>. In this case, make sure that the external device is connected properly (e.g., to the instrument's [USB TO HOST] terminal), and that it is properly transmitting a MIDI clock signal. When this is set for control by an external device (<i>USB1</i>, <i>USB2</i>, or <i>Wireless LAN</i>), the tempo is indicated as "Ext." in the Tempo pop-up display.</p> <p><b>NOTE</b> If the Clock is set other than Internal, the Style, Song, Metronome and Tempo cannot be controlled by the buttons on this instrument.</p> <p><b>NOTE</b> Wireless LAN is shown only when the USB Wireless LAN adaptor (UD-WL01) is connected to this instrument.</p>
[3 ▲▼]/ [4 ▲▼]	<i>Transmit Clock</i>	Turns MIDI clock (F8) transmission on or off. When set to <i>Off</i> , no MIDI clock or Start/Stop data is transmitted even if a Song or Style is played back.
[5 ▲▼]/ [6 ▲▼]	<i>Receive Transpose</i>	Determines whether or not the instrument's transpose setting is applied to the note events received by the instrument via MIDI.
[7 ▲▼]/ [8 ▲▼]	<i>Start/Stop</i>	Determines whether incoming FA (start) and FC (stop) messages affect Song or Style playback.

## 3 Message Switch

[1 ▲▼]– [4 ▲▼]	<i>Sys/Ex.</i>	The <i>Transmit</i> setting turns MIDI transmission of MIDI System Exclusive messages on or off. The <i>Receive</i> setting turns MIDI reception and recognition of MIDI System Exclusive messages generated by external equipment on or off.
[5 ▲▼]– [8 ▲▼]	<i>Chord Sys/Ex.</i>	The <i>Transmit</i> setting turns MIDI transmission of MIDI chord exclusive data (Chord Detect: root and type) on or off. The <i>Receive</i> setting turns MIDI reception and recognition of MIDI chord exclusive data generated by external equipment on or off.

# MIDI Transmit Settings

The explanations here apply to the *Transmit* page in step 4 on page 79. This determines which parts will be sent as MIDI data and over which MIDI channel the data will be sent.

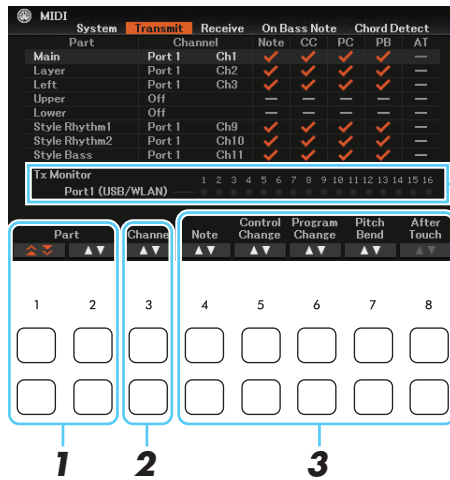

The dots corresponding to each channel (1–16) flash briefly whenever any data is transmitted on the channel(s).

**NOTE** If *WLAN* is shown, this instrument can handle MIDI messages received via the USB wireless LAN adaptor connected to the [USB TO DEVICE] terminal. When *WLAN* is not shown although the USB wireless LAN adaptor is connected, turn the instrument off then on again.

## 1 Use the [1 ▲▼]/[2 ▲▼] (Part) buttons to select the part for changing transmit settings.

You can use the [1 ▲▼] buttons to skip up or down through the part type (keyboard part, Style and Song), while you can use the [2 ▲▼] buttons to move up or down to the next part one by one.

The Parts listed on this display are the same as those shown in the *Mixer* display and *Channel On/Off* display with the exception of the two parts below.

- **Upper:** A keyboard part played on the right side of the keyboard from the Left Split Point.
- **Lower:** A keyboard part played on the left side of the keyboard from the Left Split Point. This is not affected by the on/off status of the [ACMP] button.

## 2 Use the [3 ▲▼] (Channel) buttons to select a channel via which the selected part will be transmitted.

**NOTE** If the same transmit channel is assigned to several different parts, the transmitted MIDI messages are merged to a single channel—resulting in unexpected sounds and possible glitches in the connected MIDI device.

**NOTE** Protected Songs cannot be transmitted even if the proper Song channels 1–16 are set to be transmitted.

## 3 Use the [4 ▲▼]–[8 ▲▼] buttons to enter checkmarks to the types of data to be transmitted.

The MIDI messages with checkmarks can be transmitted.

- [4 ▲▼] (*Note*): Note events
- [5 ▲▼] (*CC*): Control Change
- [6 ▲▼] (*PC*): Program Change
- [7 ▲▼] (*PB*): Pitch Bend
- [8 ▲▼] (*AT*): After Touch

# MIDI Receive Settings

The explanations here apply to the *Receive* page in step 4 on page 79. This determines which parts will receive MIDI data and over which MIDI channels the data will be received.

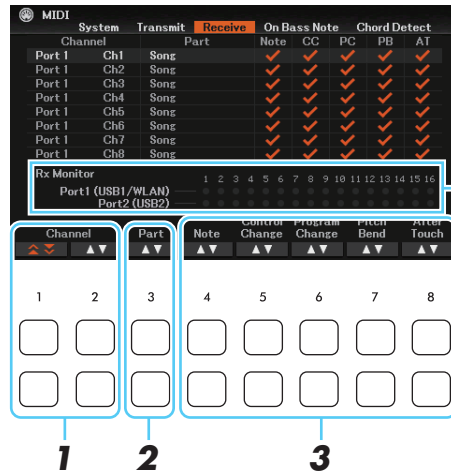

The dots corresponding to each channel (1–16) flash briefly whenever any data is received on the channel(s).

**NOTE** If *WLAN* is shown, this instrument can handle MIDI messages received via the USB wireless LAN adaptor connected to the [USB TO DEVICE] terminal. When *WLAN* is not shown although the USB wireless LAN adaptor is connected, turn the instrument off then on again.

## 1 Use the [1 ▲▼]/[2 ▲▼] (*Channel*) buttons to select the channel to be received.

You can use the [1 ▲▼] buttons to skip up or down through the next port, while you can use the [2 ▲▼] buttons to move up or down to the next channel one by one.

The instrument can receive MIDI messages over 32 channels (16 channels x 2 ports) by USB connection.

## 2 Use the [3 ▲▼] (*Part*) buttons to select the part via which the selected channel will be received.

The Parts listed on this display are the same as those shown in the *Mixer* display and *Channel On/Off* display with the exception of the following parts.

- **Keyboard:** The received note messages control the instrument’s keyboard performance.
- **Extra Part 1–5:** There are five parts specially reserved for receiving and playing MIDI data. Normally, these parts are not used by the instrument itself. The instrument can be used as a 32-channel multi-timbral tone generator by using these five parts in addition to the other parts of the instrument.

## 3 Use the [4 ▲▼]–[8 ▲▼] buttons to enter checkmarks to the types of data to be received.

MIDI messages (page 82) with checkmarks can be received.

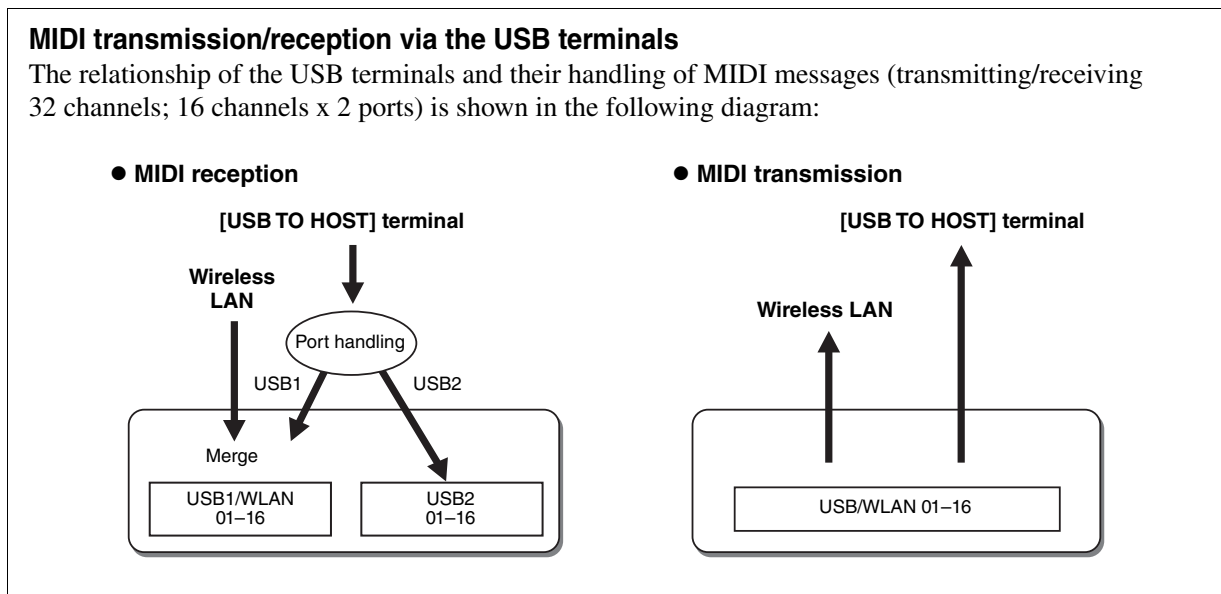

## Bass Note Settings for Style Playback via MIDI Receive

The explanations here apply to the *On Bass Note* page in step 4 on [page 79](#). These settings let you determine the bass note for Style playback, based on the note messages received via MIDI. The note on/off messages received at the channel(s) set to *On* are recognized as the bass note of the chord of Style playback. The bass note will be detected regardless of the [ACMP] button or split point settings. When several channels are simultaneously set to *On*, the bass note is detected from merged MIDI data received over the channels.

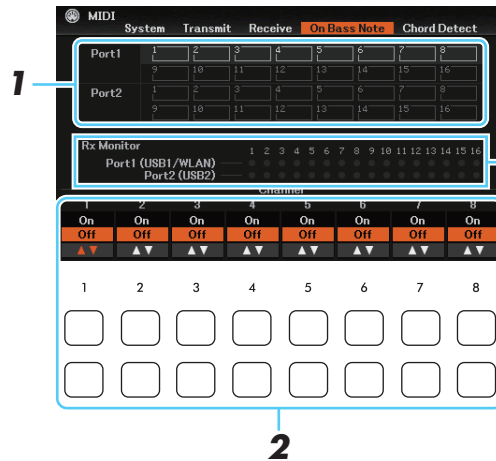

The dots corresponding to each channel (1–16) flash briefly whenever any data is received on the channel(s).

**NOTE** If *WLAN* is shown, this instrument can handle MIDI messages received via the USB wireless LAN adaptor connected to the [USB TO DEVICE] terminal. When *WLAN* is not shown although the USB wireless LAN adaptor is connected, turn the instrument off then on again.

- 1** Use the Cursor buttons [**▲**][**▼**] to select the target.
- 2** Use the [**1 ▲▼**]-[**8 ▲▼**] buttons to set the desired channel to *On* or *Off*.

## Chord Type Settings for Style Playback via MIDI Receive

The explanations here apply to the *Chord Detect* page in step 4 on [page 79](#). This page lets you select the MIDI channels over which the MIDI data from the external device will be used to detect the Chord Type for Style playback. The note on/off messages received at the channel(s) set to *On* are recognized as the notes for detecting chords in Style playback. The chords to be detected depend on the fingering type. The chord types will be detected regardless of the [ACMP] button or split point settings. When several channels are simultaneously set to *On*, the chord type is detected from merged MIDI data received over the channels.

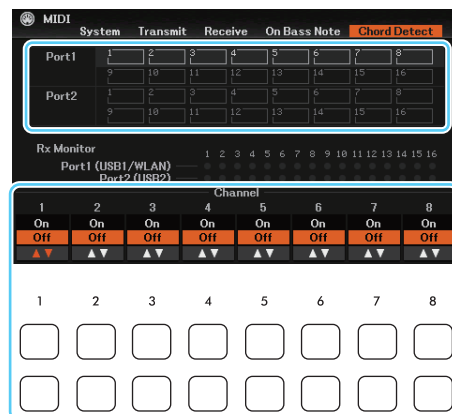

The operation procedure is basically the same as that of the *On Bass Note* page above.

# Making Wireless LAN Settings

By using a USB wireless LAN adaptor (sold separately), you can connect this instrument with a smart device such as a smartphone or tablet via a wireless network. For general operating instructions, refer to the “Smart Device Connection Manual” on the website. This section covers only operations that are specific to this instrument.

Before starting operations, make sure that the USB wireless LAN adaptor is connected to the [USB TO DEVICE] terminal and call up the setup display via [MENU] → Cursor buttons [▲][▼][◀][▶] *Wireless LAN*, [ENTER].

## NOTICE

**Do not connect this product to public Wi-Fi and/or Internet directly. Only connect this product to the Internet through a router with strong password-protections. Consult your router manufacturer for information on security best practices.**

**NOTE** If the USB wireless LAN adaptor is not recognized by the instrument, *Wireless LAN* is not shown. When *Wireless LAN* is not shown even though a USB wireless LAN adaptor has been connected, turn the instrument off then on again.

When the connection is done successfully, “*Connected*” is shown at the top of the display, and one of the icons shown below appears indicating the signal strength.



## Infrastructure Mode

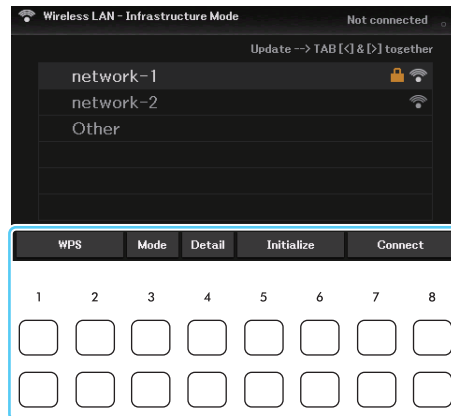

[1 ▲▼]/ [2 ▲▼]	<b>WPS</b>	Connects this instrument to the network via WPS. Press one of these buttons followed by the [7 ▲▼] ( <i>Yes</i> ) buttons, and then press the WPS button on your access point within two minutes.
[3 ▲▼]	<b>Mode</b>	Switches to the Access Point Mode.
[4 ▲▼]	<b>Detail</b>	For setting the detailed parameters. After making these settings, press one of the [7 ▲▼]/[8 ▲▼] ( <i>Save</i> ) buttons to actually save them. <ul style="list-style-type: none"> <li>• <b>IP Address:</b> Sets the IP address and other related parameters.</li> <li>• <b>Others:</b> Sets the Host name, Time Zone and Daylight Saving Time. When the instrument is connected to the network with the Infrastructure Mode, the current time is shown on the Main display.</li> </ul>
[5 ▲▼]/ [6 ▲▼]	<b>Initialize</b>	Initializes the connection setup to the default factory status.

<p>[7 ▲▼]/ [8 ▲▼]</p>	<p><b>Connect</b></p>	<p>Use the Cursor buttons [▲][▼] to select the network, and then press one of the [7 ▲▼]/[8 ▲▼] buttons to connect to the selected network. For a network having a padlock icon, the Character Entry window appears and you need to enter the password. If you select <b>Other</b>, this calls up the Manual Setup display in which you set the SSID, security method, and password. After entering those, press one of the [7 ▲▼]/[8 ▲▼] buttons in the Manual Setup display to connect to the network.</p> <p><b>NOTE</b> Pressing the TAB [◀] and [▶] buttons simultaneously updates the network list on the display.</p>
---------------------------	-----------------------	--

## Access Point Mode

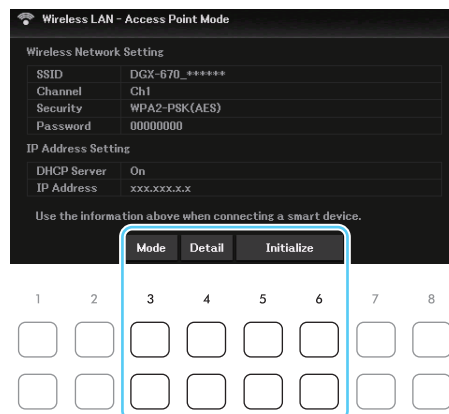

<p>[3 ▲▼]</p>	<p><b>Mode</b></p>	<p>Switches to the Infrastructure Mode.</p>
<p>[4 ▲▼]</p>	<p><b>Detail</b></p>	<p>For setting the detailed parameters on the pages below. After making these settings, press one of the [7 ▲▼]/[8 ▲▼] (<b>Save</b>) button to actually save them.</p> <ul style="list-style-type: none"> <li>• <b>Wireless Network:</b> For setting the SSID, security, password, and channel.</li> <li>• <b>IP Address:</b> For setting the IP address and other related parameters.</li> <li>• <b>Others:</b> For entering the Host name or showing MAC address, etc.</li> </ul>
<p>[5 ▲▼]/ [6 ▲▼]</p>	<p><b>Initialize</b></p>	<p>Initializes the connection setup to the default factory status.</p>

## Contents

<b>Utility</b> .....	<b>.87</b>
• Config1 .....	.87
• Config2 .....	.88
• Parameter Lock .....	.89
• USB .....	.89
<b>System</b> .....	<b>.90</b>
• Common .....	.90
• Backup/Restore .....	.90
• Setup Files .....	.90
• Reset .....	.91

This section covers only the *Utility* and *System* displays in the Menu. For other displays, refer to the “Function List” in the Owner’s Manual to see where you can find the instructions.

## Utility

### Call up the operation display.

[MENU] → Cursor buttons [▲][▼][◀][▶] *Utility*, [ENTER]

### Config1

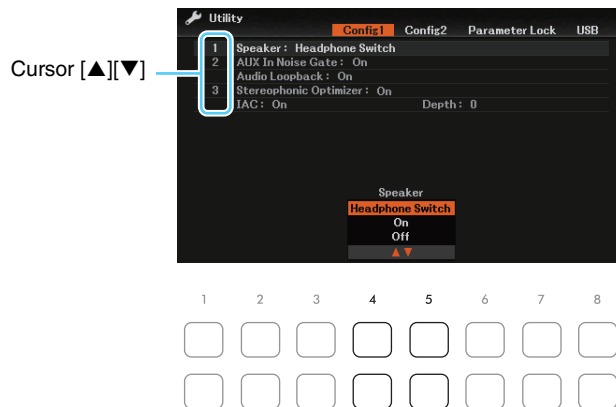

### 1 Speaker

<p>[4 ▲▼]/ [5 ▲▼]</p>	<p><i>Speaker</i></p>	<p>Determines whether or not the sound is output from the speaker of this instrument.</p> <ul style="list-style-type: none"> <li>• <b>Headphone Switch:</b> Speaker sounds normally, but is cut off when headphones or an external device is connected to the [PHONES/OUTPUT] jack.</li> <li>• <b>On:</b> Speaker sound is always on, even if headphones are connected.</li> <li>• <b>Off:</b> Speaker sound is off. You can only hear the instrument sound via the headphones or an external device connected to the [PHONES/OUTPUT] jack.</li> </ul>
---------------------------	-----------------------	--

## 2 AUX In Noise Gate, Audio Loopback

[3 ▲▼]/ [4 ▲▼]	<b>AUX In Noise Gate</b>	Turns on or off the Noise Gate which minimizes noise of the sound input via the [AUX IN] jack.
[5 ▲▼]/ [6 ▲▼]	<b>Audio Loopback</b>	Determines whether audio input from the connected computer or smart device is output to a computer or a smart device or not. For details, refer to the Owner's Manual, Chapter 9.

## 3 Stereophonic Optimizer, IAC

[2 ▲▼]/ [3 ▲▼]	<b>Stereophonic Optimizer</b>	Turns the Stereophonic Optimizer function on or off. <ul style="list-style-type: none"> <li>• <b>On:</b> This function is effective on the VRM Voices sounded from the headphones connected to the [PHONES/OUTPUT] jack.</li> <li>• <b>Off:</b> The effect of Stereophonic Optimizer is not applied.</li> </ul> <p><b>NOTE</b> In case the 1 <i>Speaker</i> setting above is <i>On</i> and headphones are connected to the [PHONES/OUTPUT] jack, this function is effective on the VRM Voices from the headphones as well as from the speakers of the instrument.</p>
[5 ▲▼]/ [6 ▲▼]	<b>IAC</b>	Turns on or off the IAC (Intelligent Acoustic Control). With this function, the sound quality of this instrument is automatically adjusted and controlled according to the overall volume. Even when the volume is low, this lets you hear both low sounds and high sounds clearly. IAC is effective only from the sound output of the instrument speakers.
[7 ▲▼]	<b>IAC Depth</b>	Adjusts the depth of the IAC. The higher the value, the more clearly that low and high sounds are heard at lower volume levels.

## Config2

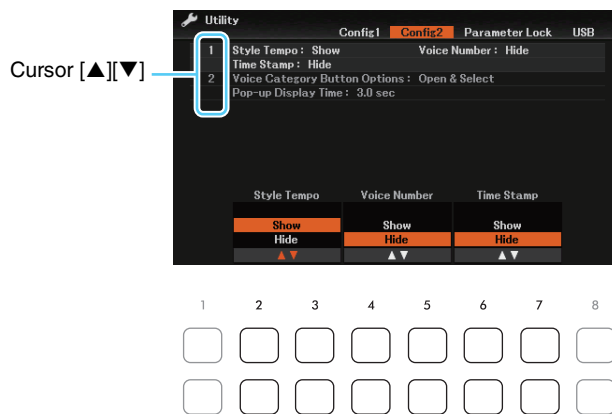

### 1 Style Tempo, Voice Number, Time Stamp

[2 ▲▼]/ [3 ▲▼]	<b>Style Tempo</b>	Determines whether the default tempo of each preset Style is shown or hidden above the Style name in the Style Selection display.
[4 ▲▼]/ [5 ▲▼]	<b>Voice Number</b>	Determines whether the Voice bank and number are shown or hidden in the Voice Selection display. Displaying these is helpful when you want to check which bank select MSB/LSB values and program change number you need to specify when selecting the Voice from an external MIDI device. <p><b>NOTE</b> The numbers displayed here start from "1." Accordingly the actual MIDI program change numbers are one lower, since that number system starts from "0."</p>



[6 ▲▼]/ [7 ▲▼]	<b>Time Stamp</b>	Determines whether the updated date and time are shown or hidden on the File Selection display. When you connect the instrument to the network with the Infrastructure Mode (page 85) by using the USB wireless adaptor (UD-WL01), the instrument gets the “clock” information and the current time stamp (date and time) is recorded to the files you save to the instrument. Once you turn the power off, the clock is set to the factory default and will not be updated unless the instrument is connected to the network.
-------------------	-------------------	---

## 2 Voice Category Button Options, Pop-up Display Time

[3 ▲▼]/ [4 ▲▼]	<b>Voice Category Button Options</b>	Determines how the Voice Selection display is opened when one of the VOICE buttons is pressed. <ul style="list-style-type: none"> <li>• <b>Open &amp; Select:</b> Opens the Voice Selection display with the previously selected Voice in the Voice category automatically selected (when one of the VOICE buttons is pressed).</li> <li>• <b>Open Only:</b> Opens the Voice Selection display with the currently selected Voice (when one of the VOICE buttons is pressed).</li> </ul>
[5 ▲▼]/ [6 ▲▼]	<b>Pop-up Display Time</b>	Determines the time in which the pop-up displays close. (Pop-up displays are shown when you press buttons such as TEMPO/TAP or TRANSPOSE, etc.)

## Parameter Lock

This lets you lock or maintain the settings of specific parameters (such as Effect and Split Point), even when the panel setups are changed by Registration Memory, One Touch Setting, etc.

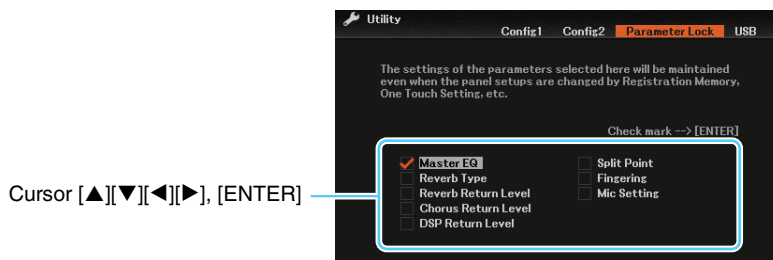

To set this function, use the Cursor buttons [▲][▼][◀][▶] to select the desired parameter, and then press the [ENTER] button to enter (or remove) checkmarks. Repeat this step as desired. Items having checkmarks will be locked.

## USB

Refer to the Owner's Manual, Chapter 9.

# System

## Call up the operation display.

[MENU] → Cursor buttons [▲][▼][◀][▶] *System*, [ENTER]

## Common

Refer to “Starting Up” in the Owner’s Manual.

## Backup/Restore

Refer to “Basic Operations” in the Owner’s Manual.

## Setup Files

The following settings can be saved as a file individually for future recall. Make all desired settings on the instrument before saving the file.

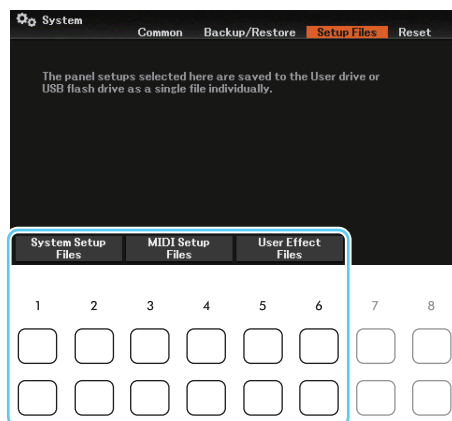

Pressing one of the [1 ▲▼]–[6 ▲▼] buttons calls up the relevant display for saving the data. On the display that is called up, select the desired destination to save the file, and then press the [6 ▼] (*Save*) button.

[1 ▲▼]/ [2 ▲▼]	<b>System Setup Files</b>	Parameters set on the various displays such as <i>Utility</i> are handled as a single System Setup file. Refer to <i>Parameter Chart</i> in the Data List (separate PDF) for details on which parameters belong to System Setup.
[3 ▲▼]/ [4 ▲▼]	<b>MIDI Setup Files</b>	The MIDI settings including the edited MIDI templates saved to the User drive (page 79) are handled as a single file.
[5 ▲▼]/ [6 ▲▼]	<b>User Effect Files</b>	The following data can be managed as a single file. <ul style="list-style-type: none"> <li>• User Microphone Settings .....page 58</li> <li>• User Effect types .....page 70</li> <li>• User Master EQ types .....page 71</li> <li>• User Master Compressor types.....page 73</li> </ul>

### To call up the saved data:

Select the desired item in the *Setup Files* display, and then select the desired file.

If you want to restore the factory programmed settings, select the file in the *Preset* tab.

# Reset

The items checkmarked on this display can be initialized to the default by pressing one of the [7 ▲▼]/ [8 ▲▼] buttons. To enter (or remove) checkmarks, use the Cursor buttons [▲][▼] to select the item, and then press the [ENTER] button.

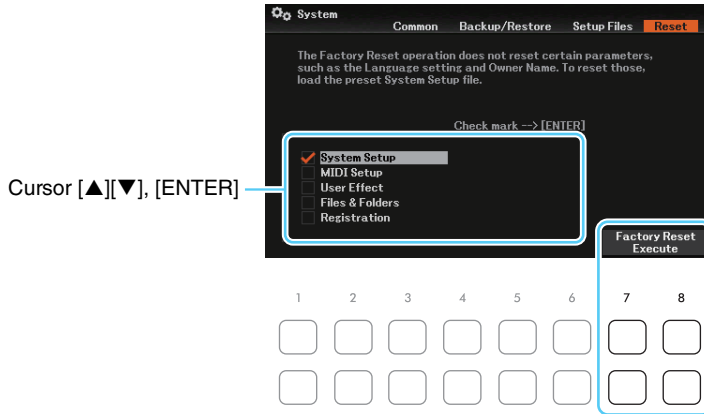

<b>System Setup</b>	Resets the System Setup parameters to the original factory settings. Refer to the <b>Parameter Chart</b> in the Data List on the website for details about which parameters belong to System Setup.
<b>MIDI Setup</b>	Resets the MIDI settings including the MIDI Setups on the USER tab display to the original factory status.
<b>User Effect</b>	Resets the current Effect settings and the following data: <ul style="list-style-type: none"> <li>• User Microphone Settings .....page 58</li> <li>• User Effect types .....page 70</li> <li>• User Master EQ types .....page 71</li> <li>• User Master Compressor types.....page 73</li> </ul>
<b>Files &amp; Folders</b>	Deletes all files and folders saved in the User drive.
<b>Registration</b>	Turns off all the REGISTRATION MEMORY [1]–[4] lamps, indicating that no Registration Memory Bank is selected although all the Registration Memory Bank files are maintained. In this status, you can create Registration Memory setups from the current panel settings. <p><b>NOTE</b> The same operation can be done by turning the power on while holding the B6 key (rightmost B key). In this case, you can create Registration Memory setups from the default panel settings.</p>

# Index

<b>A</b>			
Access Point Mode .....	86		
ACMP On/Off .....	24		
Any Key .....	51		
Articulation .....	76		
Assembly .....	32		
Audio Loopback .....	88		
AUX In Noise Gate .....	88		
<b>B</b>			
Backup .....	90		
Block Diagram .....	74		
<b>C</b>			
Channel (Song) .....	50, 55		
Channel (Style) .....	36		
Chord Detection Area .....	25		
Chord Tutor .....	21		
Chorus .....	6, 16, 68		
Common .....	90		
Compressor .....	59, 73		
Config .....	87		
<b>D</b>			
Damper Resonance .....	6		
Drum Setup .....	41		
DSP .....	16, 68		
Dynamics .....	35		
<b>E</b>			
Echo .....	8		
Effect .....	16, 60, 68		
EG (Envelope Generator) .....	15		
Ending .....	24		
EQ (Equalizer) .....	16, 59, 71		
<b>F</b>			
Factory Reset .....	91		
Fill-in .....	23, 77		
Filter .....	15, 67		
Fine-tuning .....	10		
Follow Lights .....	51		
Freeze .....	62		
<b>G</b>			
Groove .....	34		
Guide .....	50		
<b>H</b>			
High Key .....	40		
<b>I</b>			
IAC (Intelligent Acoustic Control) .....	88		
Infrastructure Mode .....	85		
Intro .....	24		
<b>K</b>			
Karao-Key .....	51		
Key Off Sampling .....	6		
Keyboard Harmony .....	7		
<b>L</b>			
Lyrics .....	47		
<b>M</b>			
Master Compressor .....	73		
Master EQ .....	71		
Metronome .....	5		
Microphone .....	58		
MIDI .....	79		
Mixer .....	66		
Modulation .....	14		
Mono .....	13		
<b>N</b>			
Noise Gate .....	59, 88		
Note Limit .....	40		
NTR (Note Transposition Rule) .....	38		
NTT (Note Transposition Table) .....	38		
<b>O</b>			
Octave .....	13		
OTS Link Timing .....	24		
<b>P</b>			
Pan .....	66		
Parameter .....	37		
Parameter Lock .....	89		
Part EQ .....	71		
Pedal .....	14, 75		
Pitch .....	10		
Play Root/Chord .....	38		
Playback (Song) .....	49		
Playback (Style) .....	23		
Playlist .....	65		
Poly .....	13		
Pop-up Display Time .....	89		
Portamento .....	14		
Punch In/Out .....	53		
<b>R</b>			
Recording (Song) .....	53		
Recording (Style) .....	28		
Registration Memory .....	61		
Registration Sequence .....	63		
Repeat Mode .....	49		
Re-recording .....	53		
Reset .....	91		
Restore .....	90		
Reverb .....	6, 16, 68		
RTR (Retrigger Rule) .....	40		
<b>S</b>			
Scale Tuning .....	10		
Score .....	44		
Setup Data (Song) .....	52		
Setup Files .....	90		
Smart Chord .....	19		
Song Creator .....	52		
Song Settings .....	49		
Source Root/Chord .....	38		
Speaker .....	87		
Stereophonic Optimizer .....	88		
Stop ACMP .....	25		
String Resonance .....	6		
Style Creator .....	26		
Style Settings .....	23		
Synchro Stop .....	24, 77		
System .....	90		
System Reset .....	91		

## **T**

Tap Tempo .....	5
Text .....	47
Time Stamp .....	89
Touch Sense .....	13
Tuning .....	10

## **U**

Unison .....	76
Utility .....	87

## **V**

Vibe Rotor .....	16
Vibrato .....	15
Voice Set (Voice Edit) .....	12
Voice Set Filter .....	17
Volume .....	66
VRM .....	6

## **W**

Wireless LAN .....	85
--------------------	----

## **Y**

Your Tempo .....	51
------------------	----